

## PLIDCO® FLANGE

**Mates with standard flanges without special pipe preparation**

The PLIDCO® Flange is a mechanical fitting which does not require welding unless specified by the customer. They are particularly useful for making tie-in connections for prefabricated expansion and re-work projects in weld hazardous areas. PLIDCO® Flanges are easy and safe to install for many applications including hard to reach places such as overhead piping, conduits, tunnels, tight manifolds or hazardous locations.

Special installation instructions are necessary for thin wall applications. Contact PLIDCO® for details.

PLIDCO® Flanges are available in standard sizes 1.5" through 48"; ASME class 150 through ASME class 600. Special sizes and pressures are available upon request.

Buna-N packing is standard. Viton, Silicone and other packings are available upon request.

**Standard body materials:**

- ASTM A106 Gr. C
- ASTM A105
- ASTM A350 Gr. LF2

**Options:**

- Marine epoxy paint for corrosion protection
- NACE MR0175 / ISO 15156 compliant materials



MAXIMUM WORKING PRESSURE -20° F TO 100° F								
API PIPE SIZE	PIPE ANCHORED				PIPE NOT ANCHORED			
	ANSI 150#	ANSI 300#	ANSI 400#	ANSI 600#	ANSI 150#	ANSI 300#	ANSI 400#	ANSI 600#
1.5"	285	740	990	1480	285	740	990	1480
2"	285	740	990	1480	285	740	990	1480
3"	285	740	990	1480	285	740	990	1247
4"	285	740	990	1480	285	740	990	1131
6"	285	740	990	1480	285	696	696	696
8"	285	740	990	1480	285	513	513	513
10"	285	740	990	1480	285	396	396	396
12"	285	740	990	1480	285	328	328	375
14"	285	740	990	1480	285	311	311	250
16"	285	740	990	1480	238	238	238	268
18"	285	740	990	1480	251	251	251	282
20"	285	740	990	1480	203	203	203	229
24"	285	740	990	1480	212	212	212	247

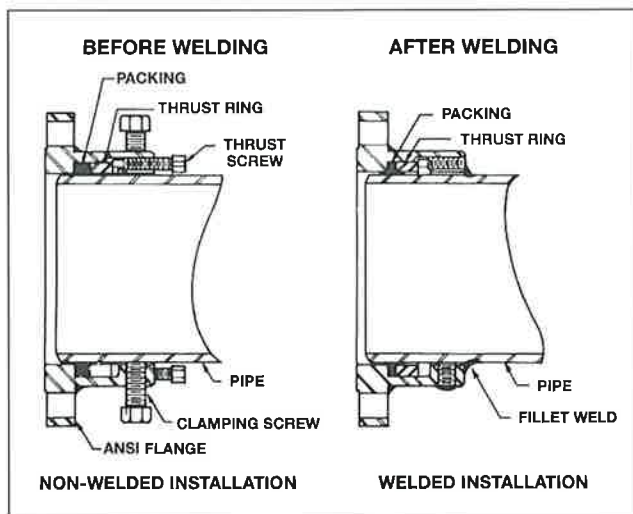

# PLIDCO®

The Pipe Line Development Company  
870 Canterbury Road • Cleveland, Ohio 44145  
Phone: (440) 871-5700 • Fax: (440) 871-9577  
Toll Free: 1-800-848-3333  
web: www.plidco.com • e-mail: pipeline@plidco.com

## PLIDCO®+FLANGE COUPLING INSTALLATION INSTRUCTIONS

### !! WARNING!!

IMPROPER SELECTION OR USE OF THIS PRODUCT CAN RESULT IN EXPLOSION, FIRE, DEATH, PERSONAL INJURY, PROPERTY DAMAGE AND/OR HARM TO THE ENVIRONMENT.

### READ CAREFULLY

The person in charge of the installation must be familiar with these instructions and communicate them to all personnel involved. Do not use or select a Plidco+Flange until all aspects of the application are thoroughly analyzed. Do not use the Plidco+Flange until you read and understand these installation instructions. Every effort has been made to securely package this product prior to shipment. Thoroughly inspect for any damage that may have occurred during shipment. If you have any questions, or encounter any difficulties using this product, please contact:

**PLIDCO "DEPARTMENT 100" at 440-871-5700  
toll free U.S. & Canada at 800-848-3333**

### **Safety Check List**

- Read and follow these instructions carefully. Follow your company's safety policy and applicable codes and standards.
- Be absolutely certain that the correct seal material has been selected for the intended use.
- Determine the type of joint that the Plidco+Flange coupling is expected to connect. See (a) and (b) below and determine the appropriate pressure rating from the ratings listed on the label of the Plidco+Flange coupling.

#### (a) Pipe Not Anchored

A joint in which the pipe ends could move when subjected to internal or external forces, such as internal pressure, temperature expansion and contraction, underwater currents, ground movement or any combination thereof. The assigned Plidco+Flange *Pipe Not Anchored* rating considers only the end force created by the internal pressure. It does not consider any additional external forces such as temperature expansion and contraction, underwater currents, ground movement or any combination thereof. These additional external forces must be determined by the customer. If any of these forces cannot be restrained by customer proven techniques, a Plidco Clamp+Ring must be used.

(b) Anchored Pipe

A joint in which the pipe ends would not move when subjected to the forces listed under *Pipe Not Anchored*. The Plidco+Flange *Anchored Pipe* rating is the maximum pressure at which the pipeline can be operated. It assumes that the pipeline is suitably anchored by welding, by the use of an appropriately rated Plidco Clamp+Ring or by other customer proven techniques.

- Pipe wall thickness less than those listed may be pushed inward by the force of the clamp screws. Contact Plidco for recommended maximum working pressure and revised clamp screw torque values for pipe wall thicknesses thinner than listed below.

Minimum Pipe Wall Thickness for a Plidco+Flange	
Nominal Pipe Size (inches)	Wall Thickness (inches)
1½	0.200
2	0.218
2½	0.276
3	0.237
4	0.237
6	0.280
8	0.322
10	0.365
12	0.406
14	0.438
16 & larger	0.500

- A Plidco Clamp+Ring should be considered whenever the wall thickness is less than those listed. A Plidco Clamp+Ring should also be considered where high external forces (such as underwater currents or thermal contractions) are anticipated, even if the pipe has an adequate wall thickness.
- Pipelines should be carefully blocked at elbows and bends to prevent pullouts caused by internal and external forces; or a Plidco Clamp+Ring should be used. The pipeline should be evenly supported before repressuring. Follow applicable B31 codes during repressuring.
- If the Plidco+Flange coupling is welded according to our instructions, or a suitable Plidco Clamp+Ring is used, it can be considered an anchored joint.
- Observe the pressure and temperature ratings on the label of the Plidco+Flange coupling. Repressuring should be accomplished slowly and steadily without surges that could vibrate the pipeline and fitting. Industry codes and standards are a good source of information on this subject. Except for testing purposes, do not exceed the design pressure of the Plidco+Flange. Refer to the section on Field Testing for precautions. Personnel should not be allowed near the installation until the seal has been proven.

## Pipe Preparation

1. The pipe surface in the area of the repair should be clean, free of coating and burrs and lubricated to prevent abrasion to the seals.
2. For badly misaligned or out-of-round pipe, it is helpful to grind a pilot bevel with a generous taper on the pipe. This will eliminate the risk of damage to the seals while slipping the Plidco+Flange coupling over the end of the pipe. (See Figure 1)

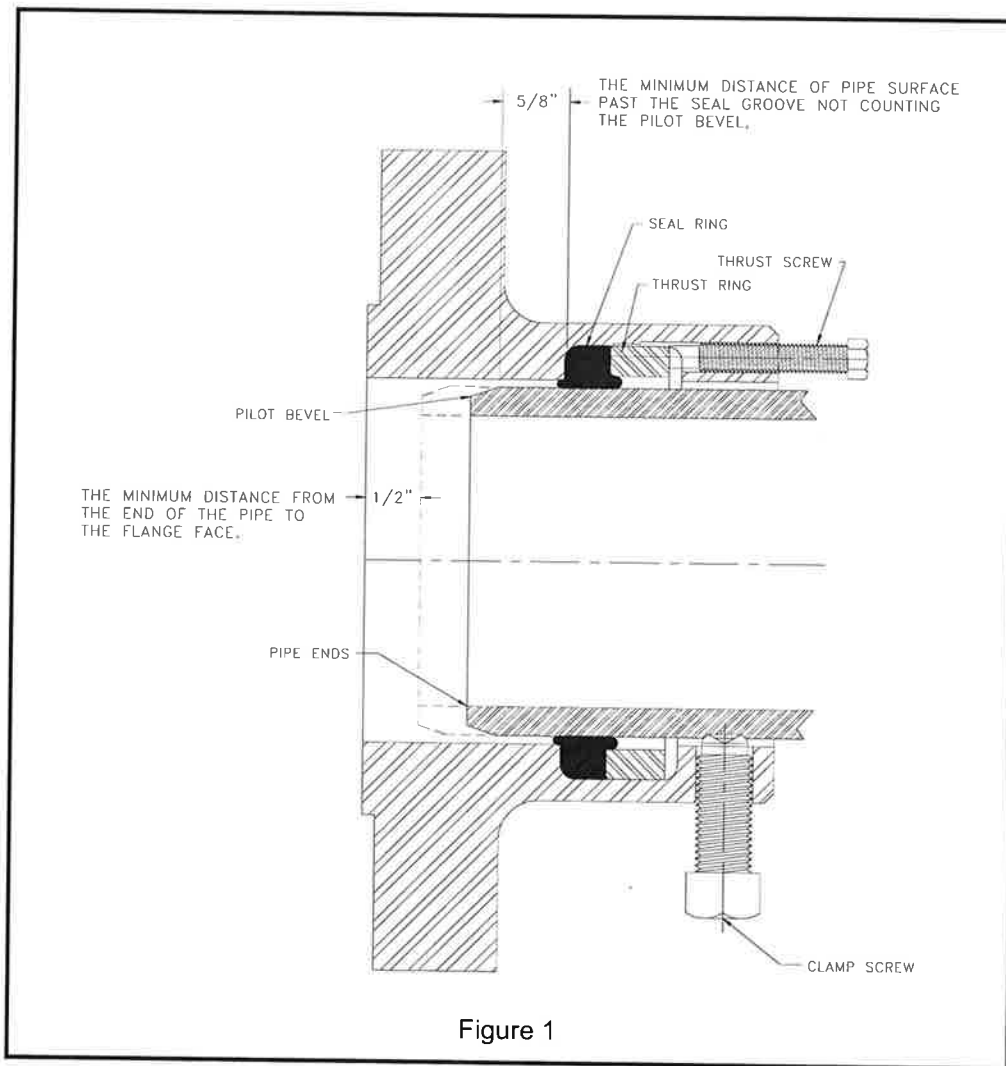

## Installation

The exact order of the installation steps may vary depending on the particular configuration of the piping components being repaired or replaced. The seals can be damaged by careless handling. Lifting devices such as chains, cables or lift truck forks should not contact the seals. Failure to do so can result in the seals being damaged or pulled from their grooves.

1. Measure and record dimension "D", as shown in Figure 2. This will be needed later if the Plidco+Flange is welded to the pipe.
2. Coat all exposed surfaces of the seal material with a lubricant. The chart on the next page indicates the lubricants that are recommended for the various seal materials. The customer must determine if the lubricant is compatible with the product in the pipeline.

Petroleum based lubricants	= A	
Silicone based lubricants	= B	
Glycerin based lubricants	= C	
Super Lube® Grease (1)	= D	
		Temperature (2)
Buna-N	A, B, C, D	225°F
Viton	A, B, C, D	250°F
Silicone	C, D	300°F
Neoprene	B, C, D	250°F
Aflas	A, B, C, D	225°F
Hycar	A, B, C, D	180°F
Teflon	A, B, C, D	500°F
Kevlar	A, B, C, D	750°F

- (1) Super Lube® Grease is a product of Synco Chemical Corporation. ([www.super-lube.com](http://www.super-lube.com))
- (2) Temperature limit is for the seal material only and does not imply the pressure rating is necessarily applicable at this limit.

3. Slide the pipe into the Plidco+Flange coupling so that the end of the pipe is at least 5/8" past the seal ring (not counting the pilot bevel). The distance from the end of the pipe to the flange face should not be less than 1/2". (See Figure 1)
4. The flange bolts should be installed and tightened before the clamp screws and thrust screws are tightened. This is critical if the pipes or components being joined are not free to move. Tightening the flange bolts after the clamp and thrust screws will drag the clamp screw cup points and seal along the pipe, causing damage to both.
5. Clamp screws have case hardened cup points which are used to secure the coupling to the pipe. The shanks are mild steel and fully weldable. Clamp screws must be tightened evenly, maintaining an equal space between the pipe and the coupling using the recommended torque values. Clamp screws are designed for the assigned *Pipe Not Anchored* rating, which considers only the end force created by the internal pressure. Clamp screws do not consider any additional external forces or stresses imposed on the pipeline. (See Safety Check List, (a) *Pipe Not Anchored*)
6. Accurate clamp screw torque values are very important when the Plidco+Flange coupling is used on a pipeline joint that is NOT ANCHORED. Do not exceed the *Pipe Not Anchored* rating listed on the label of the Plidco+Flange until subsequent welding has been completed or the pipe is anchored by other means, such as a Plidco Clamp+Ring. **FAILURE TO DO SO CAN RESULT IN EXPLOSION, FIRE, DEATH, PERSONAL INJURY, PROPERTY DAMAGE AND/OR HARM TO THE ENVIRONMENT.**
7. Check all the clamp screws to make certain each has been tightened to the minimum torque specified in the chart below. As noted in the Safety Check List, contact Plidco for the maximum allowable working pressure and the revised clamp screw torque value for thin wall pipe.

Cup Point Clamp Screws	Minimum Torque	
	(ft-lbf)	(Nm)
5/8-11	100	136
3/4-10	150	240

8. Thrust screws activate the seals. They are made of mild carbon steel and are fully weldable. They should be tightened gradually and uniformly around the circumference. First, snug all the thrust screws firmly. Then advance each thrust screw about 1/8 of a turn before proceeding to an adjacent thrust screw. It will be necessary to make many circuits around the coupling before completing the thrust screw torque operation. Use the recommended torque values shown in the following chart.

Thrust Screws	Torque Range	
	(ft-lbf)	(Nm)
3/8-16	20 - 25	28 - 34
1/2-13	30 - 40	41 - 55
5/8-11	70 - 80	95 - 109

### Repressuring and Field Testing

Repressuring after the installation should be done with extreme caution; slowly and steadily without surges, which could vibrate the pipeline and fitting. Industry codes and standards are a good source of information on this subject. Except for testing purposes, operating pressure must not exceed the *Anchored Pipe* or *Pipe Not Anchored* rating, as appropriate. The Plidco+Flange can be field tested up to 1½ times the *Anchored Pipe*, if applicable. In the unanchored condition the Plidco+Flange must not be tested above the *Pipe Not Anchored* rating. Read and fully understand the definition of *Anchored Pipe* and *Pipe Not Anchored* as listed in the *Safety Check List* before pressurizing the line. Personnel should not be allowed near the repair until the installation has been proven.

### Field Welding Instructions

Failure to follow field welding instructions could result in explosion, fire, death, personal injury, property damage and/or harm to the environment.

### **PIPELINE SHOULD BE FULL AND UNDER FLOW USE ANCHORED PIPE OR PIPE NOT ANCHORED RATING AS APPLICABLE**

Use weld material with equal or greater tensile strength than the pipe. Carefully control the size and shape of the circumferential fillet welds. The weld is required to anchor the joint and give longitudinal stability to the pipeline. The size of the fillet weld should be at least 1.4 times the wall thickness of the pipe. This assumes a 1.0 joint efficiency. You may need to select a different joint efficiency based on your level of inspection or your company's welding policy.

Strive for a concave faced fillet weld, with streamlined blending into both members; avoid notches and undercuts. The smoother and more streamlined the weld, the greater the resistance to fatigue failure. The worst possible shape would be a heavy reinforced convex weld with an undercut. Improper weld shape can lead to rapid fatigue failure, which can cause leakage, rupture or an explosion with attendant serious consequences.

Welders and weld procedures should be qualified in accordance with API Standard 1104, *Welding of Pipelines and Related Facilities*, Appendix B, *In-Service Welding*. We strongly recommend the use of a low hydrogen welding process such as GMAW or SMAW using low hydrogen electrodes (E-XX18) because of their high resistance to moisture pick-up and hydrogen cracking. SMAW electrodes must be absolutely dry. It is very important that the field welding procedure closely follow the essential variables of the qualified procedure so that the quality of the field weld is represented by the mechanical tests performed for the procedure qualification.

We do not recommend the use of thermal blankets for pre-heating. Thermal blankets can generate hot spots and reduce the ability of the Plidco+Flange to dissipate welding heat in the vicinity of the seals. We recommend a small torch, such as a cutting torch, being careful not to aim the flame directly into the gap between the Plidco+Flange and the pipe towards the seals. The flame from a preheat torch is helpful in burning off oils and other contaminants. Do not use a large torch, commonly called a rosebud, because of the difficulty controlling the size of the area being preheated.

Dimension "D", as measured during the initial installation, may now be used to mark off locations "A" and "B", as shown in Figure 2. These locations are the same distance from the weld as the seal location "C". To prevent damage to the seals, monitor the heat generated by welding or preheating, particularly at location "A" and "B", by using temperature crayons or probe thermometers. If the heat generated approaches the temperature limit of the seal material, which is indicated in the seal lubrication chart, welding should be discontinued or sequenced to another part of the fitting so that the affected area has a chance to cool.

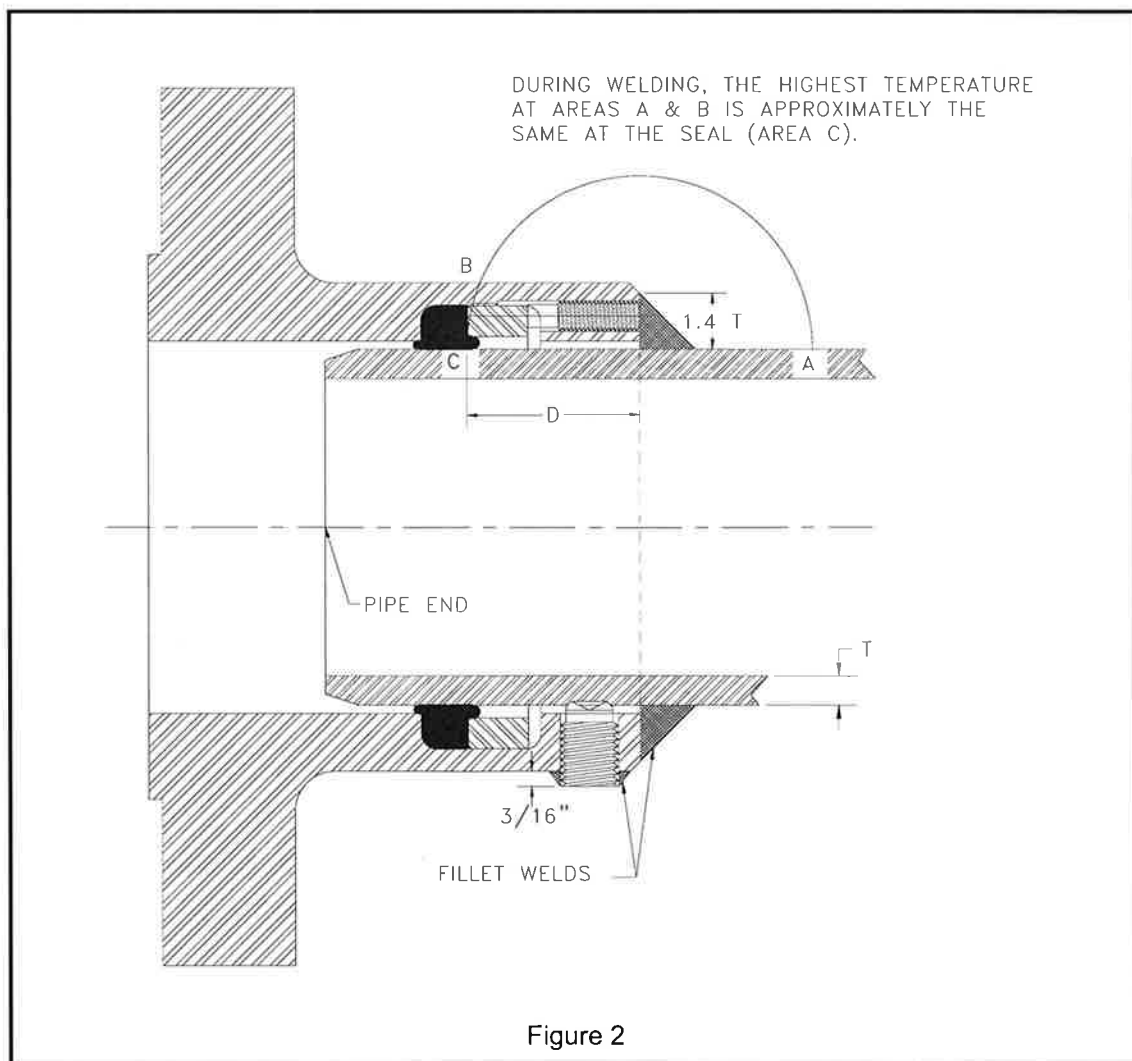

## Welding Sequence

1. Caution should be observed so that welding or preheating does not overheat the seals. Sequence the welding so that the heat is not concentrated in one area.
2. Thrust screws should be cut or burned off flush. Start with the fillet weld to the pipe around circumference and include seal welding the thrust screws. (See Figure 2)
3. Cut or burn off clamp screws approximately 3/16" above the outside surface of the coupling and seal weld. After the circumferential fillet welds are finished, one clamp screw per end may be removed to serve as a vent while welding and also as a final test point for leakage. (See Figure 2)

## Storage Instructions

Plidco+Flange couplings should be stored in a dry environment to prevent the unpainted surfaces from rusting. Storage temperatures should not exceed 120°F (50°C). Cover with a dark polyethylene to keep the direct sunlight from the seals. It is best to exclude contamination, light, ozone and radiation. Improperly stored Plidco+Flange couplings can cause the seal material to become cracked and brittle and lose its ability to seal.

## Traceability

Plidco+Flanges, as most Plidco products, have a unique serial number by which the fitting is fully traceable. Additionally, all elastomer seals have a unique batch number by which the seal material is traceable.



**Notes**

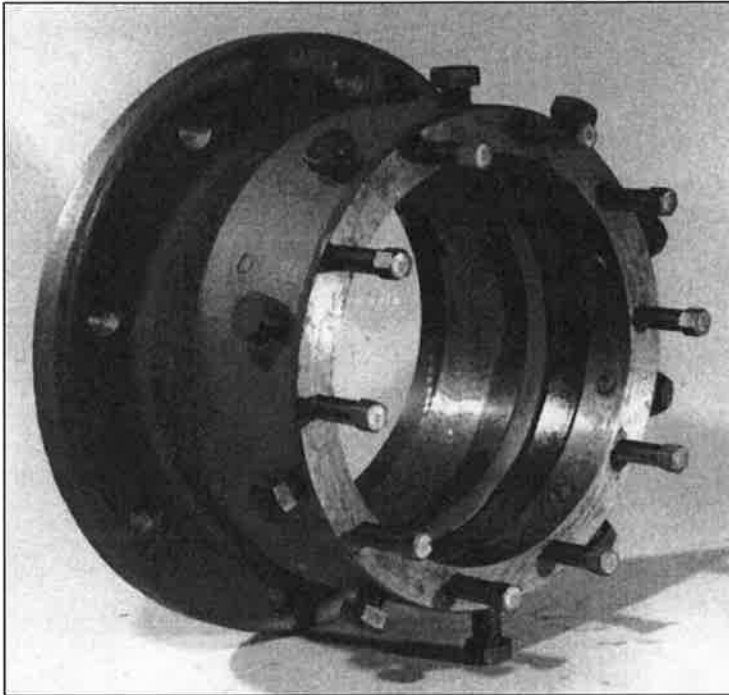

The Plidco Flange slips over the ends of pipe, seals off like PLIDCO Weld+Ends Couplings and mates up with standard flanges.

They are especially useful in weld-hazardous areas.

Plidco Flanges may be welded or bolted in place for later removal.

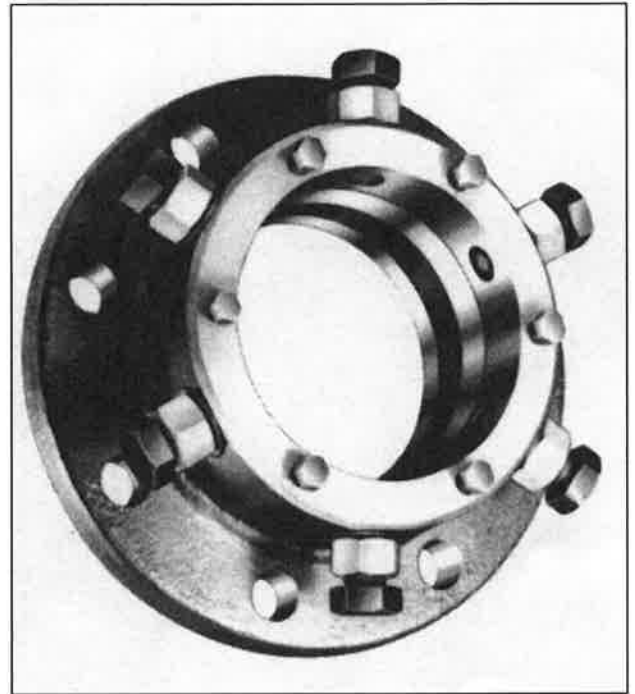

Plidco Flange with lock nuts for areas of high vibration.

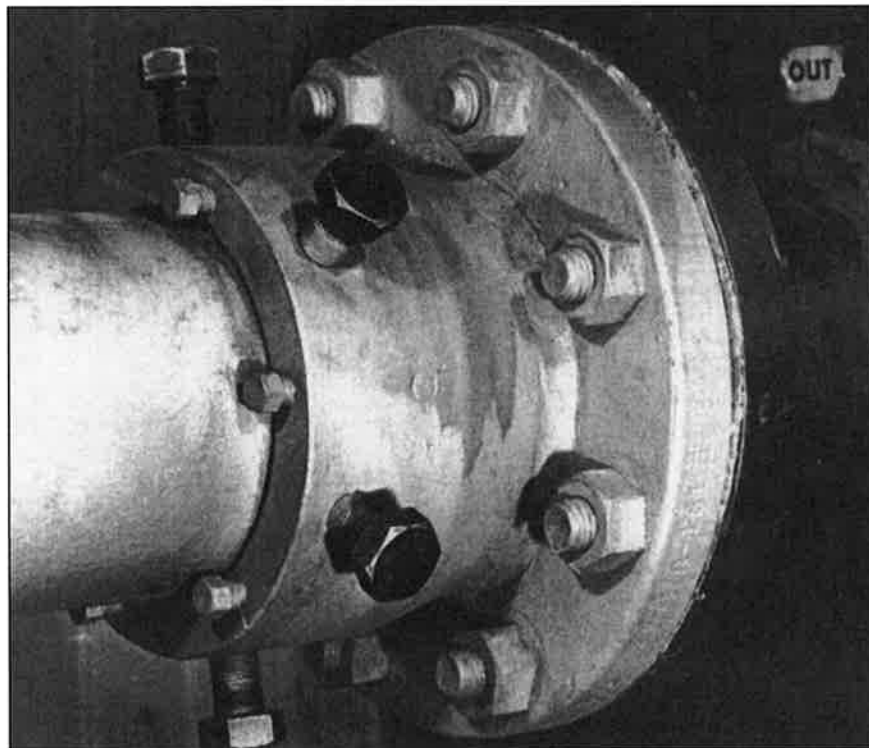

4" 150# Plidco Flange mated to a corresponding flange.

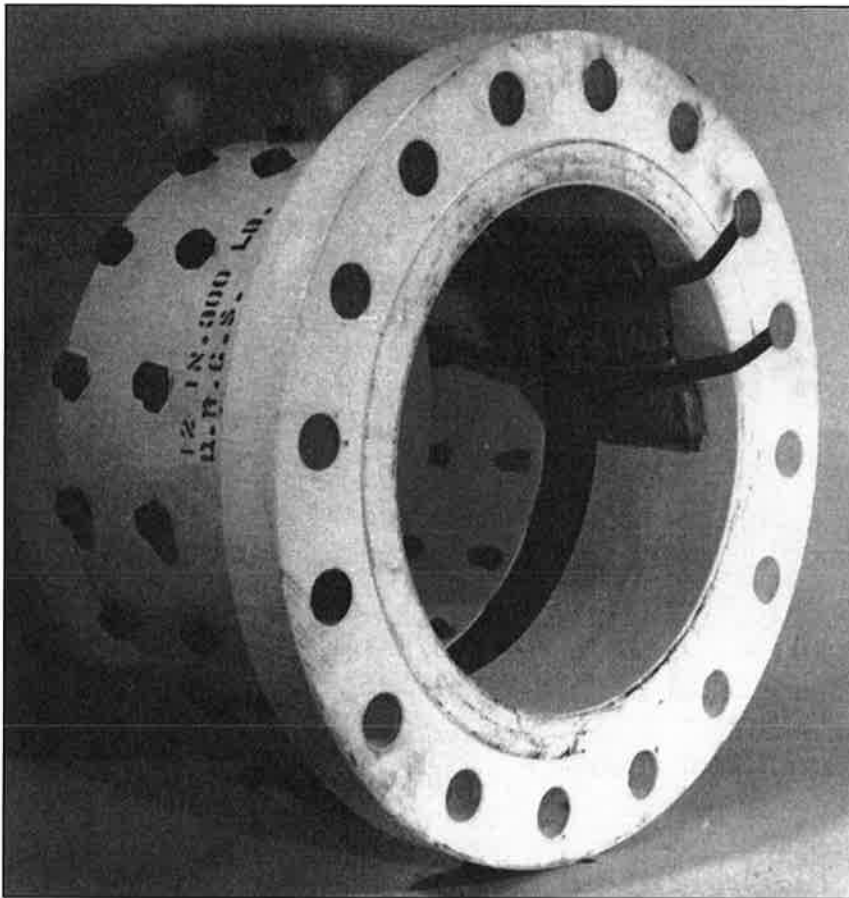

12" 300# Plidco Flange with a double row of clamping screws, for underwater installation.

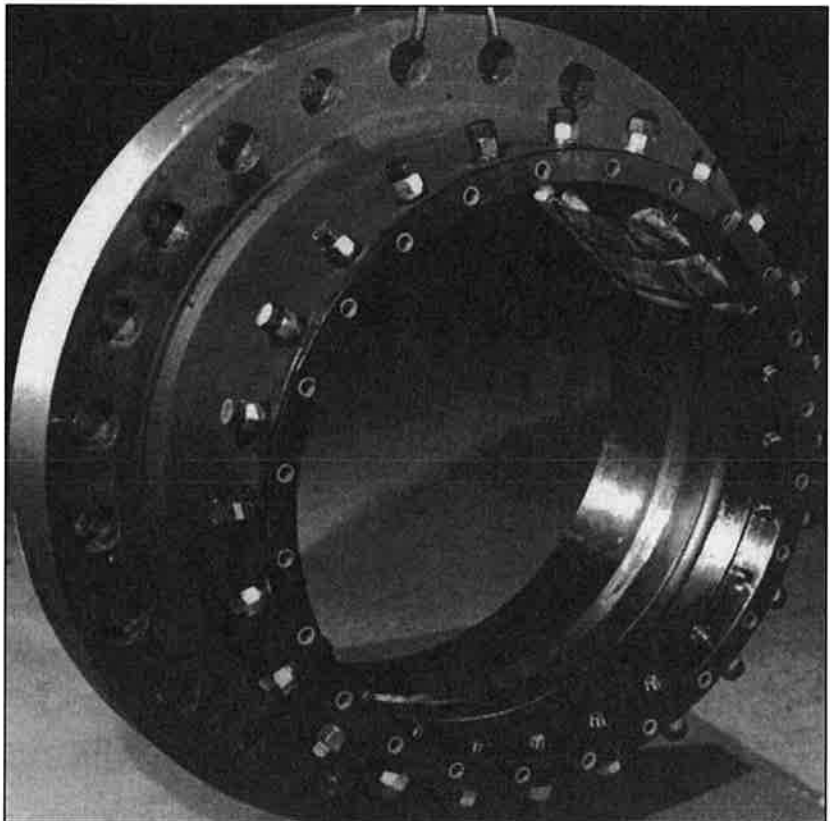

24" 300# Plidco Flange

Plidco Flanges for larger sizes and other pressure ratings are available on application.