

iSCOUT *expert compact*

Graphics console



Contents

General Information	1
Important Notes	2
System Description	3
Configuration Setup	4
Inspection checks before start-up	5
Service and Maintenance	6
Troubleshooting	7
Appendix	

Operator's Manual

Issue 5/2007 Rev. A

This document is listed under Order No.
50 650 19 0101e (Grove RT 530E)

TABLE OF CONTENTS

1. General Information	3
2. Important Notes	4
3. System Description	5
3.1 System Function	6
3.2 Operator's Console	7
3.3 Displays and operating elements	8
3.4 Description of the status symbols	14
4. Configuration Setup	16
4.1 Interactive operating mode setup	17
4.2 Quick adjusting the reeving or selecting the hoist	21
4.3 Programming geometrical limits	24
4.3.1 Radius limitation	25
4.3.2 Tip height limitation	27
4.3.3 Boom angle limitation	29
4.3.4 Slewing angle limitation / Virtual wall definition	31
Slewing angle limitation	31
Virtual wall definition	33
5. Pre-operational Inspection	36
5.1 Operation	38
6. Service and Maintenance	39
6.1 Information and Service Menus	40
7. Troubleshooting	42
7.1 General Notes	42
7.2 Malfunction Table	43
Appendix: Description of info/service menu structure	48
Appendix: Important Notes	58

1. GENERAL INFORMATION

The purpose of the **IFLEX2** load moment limitation and control system with **ISCOUT** expert compact console is to provide the crane operator with important information necessary for the operation of the crane within the areas of operation specified by the manufacturer. The LMI uses a variety of different sensors to monitor different crane functions and communicates the crane performance data to the crane operator on a continuous basis. This data changes constantly in connection with the crane movements.

If the crane nears its safe load limit, the system will warn the crane operator by means of both acoustic and optical signals. In addition, as soon as the crane reaches an unauthorized operating status, all crane movements will be switched off that would increase the load moment on the crane.

The PAT **IFLEX2** system uses a graphics operator interface, the functionality of which is determined by the crane manufacturer. The selection of the programmed functions is considerably simplified by the use of symbols.

The load moment limitation and control system based on the PAT **IFLEX2** is made up of main components that are connected via a CAN bus.

The manufacturer reserves the right to modify the contents of this manual without notice. Hirschmann offers no guarantee whatsoever for this material, including guarantees with reference to commercial availability and suitability for particular applications. Hirschmann shall not be liable for errors contained herein or for identical or consequential damages in connection with the furnishing, performance, or use of this manual. This manual is protected by copyright. All rights reserved. The manual may not be copied, reproduced or translated into another language, neither whole nor in part, without advance written authorization from Hirschmann.

2. IMPORTANT NOTES

The LMI is an operating aid that warns the crane operator of imminent overloading or of the approach of the hook block to the boom head, in order to avoid possible property damage or injury to personnel.

The device is not, nor is it intended to be, a substitute for good operator judgment and/or experience, nor does it remove the need for utilizing only recognized safe procedures during crane operations.

CAUTION

The crane operator continues to bear ultimate responsibility for safe operation of the crane. He must ensure that he fully understands and follows the displayed notes and instructions in their entirety.

Before beginning crane operations, the crane operator must carefully read and understand the entire manual in order to ensure that he is aware of the operation and limitations of both the LMI and the crane itself.

Proper functioning is dependent upon proper daily inspection and observation of the operating instructions set forth in the manual.

WARNING

The LMI is not able to provide aid to the crane operator unless it has been properly adjusted and unless the correct load capacity chart and the correct operating code have been entered for the respective rigging configuration. The correctness of the LMI settings must be guaranteed before beginning crane work in order to avoid damage to property and severe or even fatal injuries to personnel.

WARNING

This system can be equipped with an external key-operated switch located in the crane operator's cab. This key-operated switch overrides control lever function switch-off by the LMI or by the hoist limit switch system. This switch may only be used during emergency situations, and even then only by authorized personnel. Failure to observe these instructions could result in damage to property and severe or even fatal injuries to personnel.

WARNING

The LMI cannot perform correctly unless it has been properly adjusted. The prerequisite for this is making conscientious and correct entries during the set-up procedure, in accordance with the actual configuration of the crane. The correctness of the LMI settings must be ensured before beginning crane work in order to avoid damage to property and severe or even fatal injuries to personnel.

3. SYSTEM DESCRIPTION

The PAT load moment limitation and control system consist of an **iFLEX2** central unit, an **iSCOUT expert compact** CAN console and various sensors for recording the measured values.

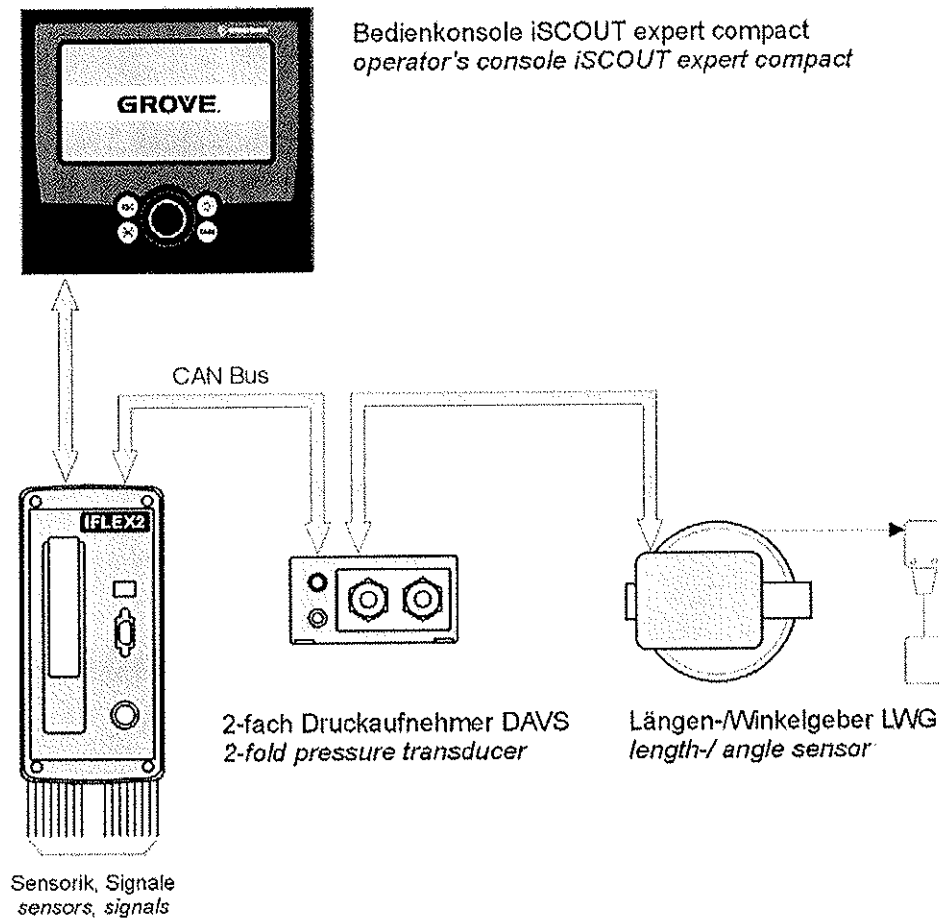

Fig. 1: Components of the LMI system with **iFLEX2**

The system operates on the principle of reference/real comparison. The actual value is compared with the calculated reference values and evaluated by the system. An overload warning signal is triggered on the display and operating console once limit values are reached. All crane movements that increase the load moment are switched off at the same time.

The crane-specific data specified by the manufacturer, such as load capacity charts, boom weights, centers of gravity and dimensions, are stored in the central data memory. This data is the reference information used to calculate the operating conditions.

The boom angle is registered by means of an angle sensor that is mounted on the boom. The crane load is determined indirectly with the aid of force and/or pressure absorbing devices.

3.1 SYSTEM FUNCTION

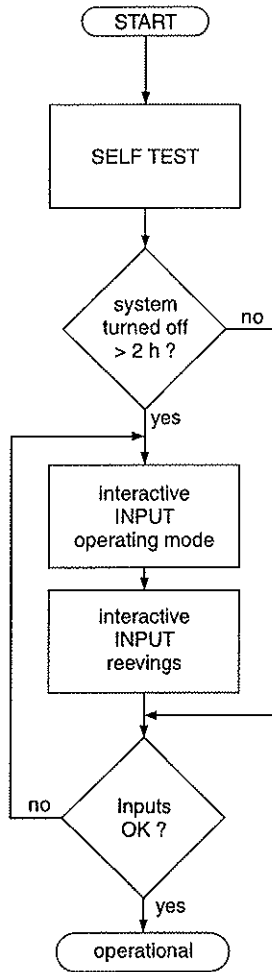

Upon switching on, the system starts with an automatic test of the LMI system, of lamps and audible alarm. During the test, the LC display shows the start screen.

If the system was turned off for more than two hours, the setup configuration has to be entered after the system test. (⇒ chapter 4)

First, the operating mode is determined by an interactive step-by-step interrogation of the rigging states.

Next is the interactive input of the reevings.

Now the LC display shows all inputs and awaits acknowledgment or cancelling.

Upon acknowledgment of the inputs the system is ready for operation. In the event of a disruption, a corresponding error code "E##" will appear on the Data display (1). (> refer to error code table)

3.2 OPERATOR'S CONSOLE

The console has several functions:

- Entries into the LMI system made by the crane operator (mode of operation, number of reevings, etc.)
- Important data and information displays during crane operation
- input of geometry limit values and cut-off if exceeding limits
- Call-up and display of system information for operator and service personnel

The operating console is located in the operator's cab in plain view of the crane operator. All displays have background illumination for enhanced ease of recognition. The console contains various operating elements as well as a multifunction LC display, all of which are described in detail in Chapter 3.3.

The background illumination of the operating elements and the LC display is adjustable manually in accordance with ambient light levels.

3.3 Displays and operating elements

Figure 1 shows the display and operating elements of the iSCOUT **expert compact** console. The numbers in this illustration correspond to the numbers of the following functional characteristics for each element:

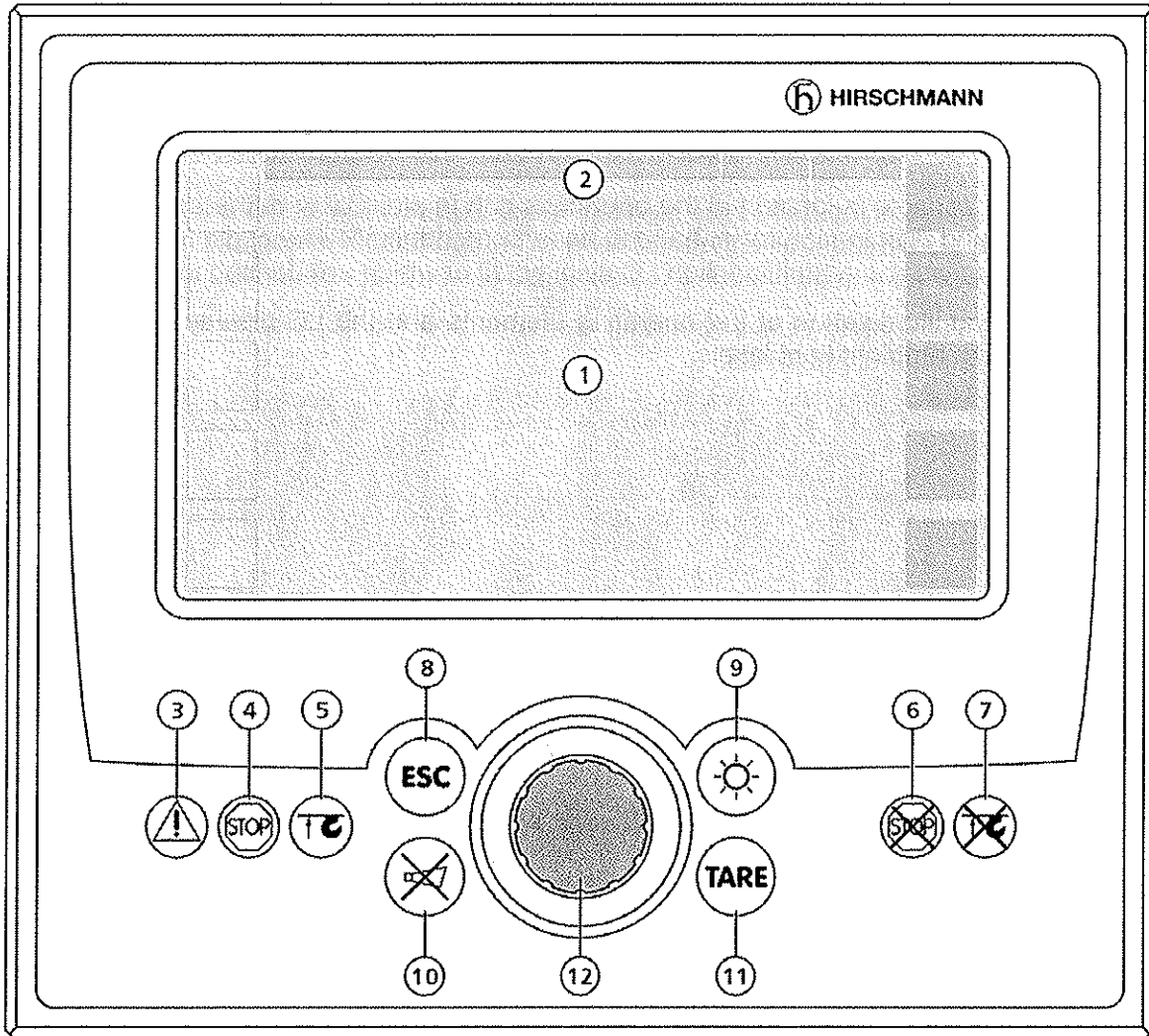

Fig. 2

- | | | | |
|---|---------------------------------------|----|---|
| 1 | Data display | 7 | "Hoist limit override" warning light |
| 2 | Utilization display field (bar graph) | 8 | "ESC" pushbutton (to main menu) |
| 3 | Prewarning lamp (load moment) | 9 | "Settings > Brightness" pushbutton |
| 4 | Overload warning lamp (load moment) | 10 | "Alarm off" pushbutton |
| 5 | "Hoist limit" warning light (A2B) | 11 | "TARE" pushbutton |
| 6 | "LMI override" warning light | 12 | Rotary selection wheel with push button |

System Description

(1) Data display

The *Data display* (1) is an 6.5" LC color graphics display with background illumination which shows required data such as load values, geometry and crane data, symbols, etc., depending on the respective operating status.

Normal LMI display: (Illustration in black/white)

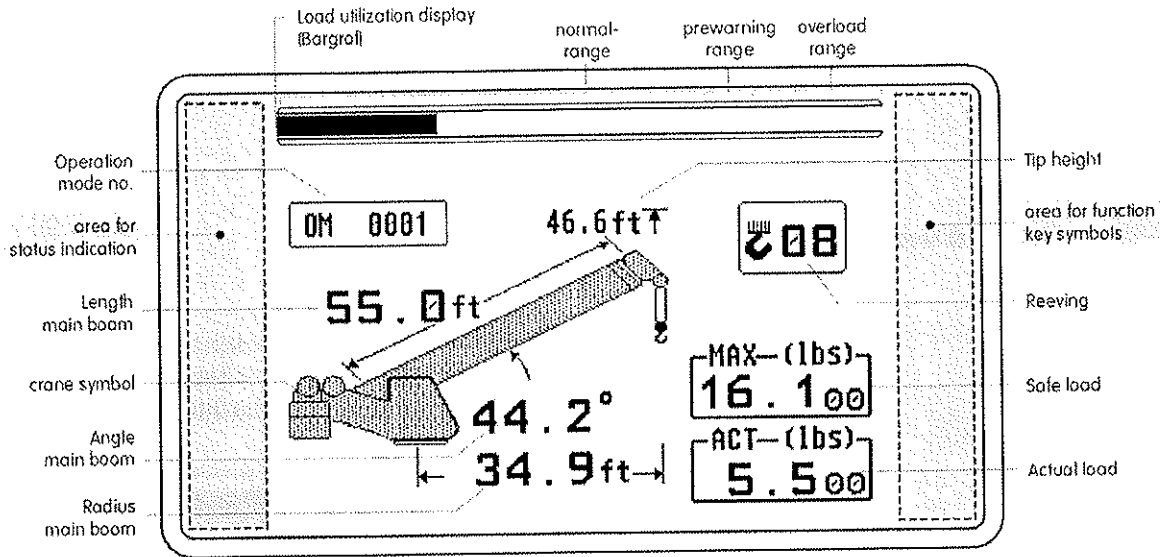

Other display examples:

Set-up Menu (mode of operation)

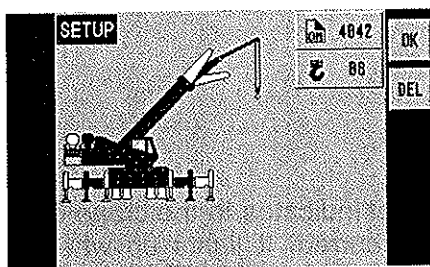

Standard LMI screen

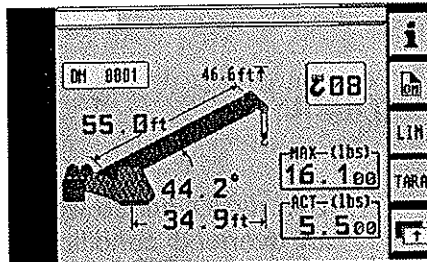

Limits Menu

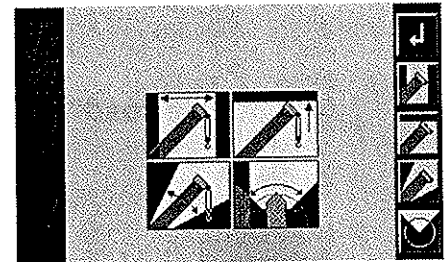

INFO Menu (CAN Node 2)

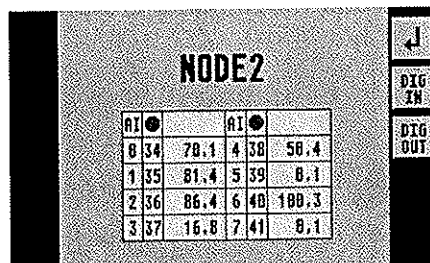

Service Menu (Bus Information)

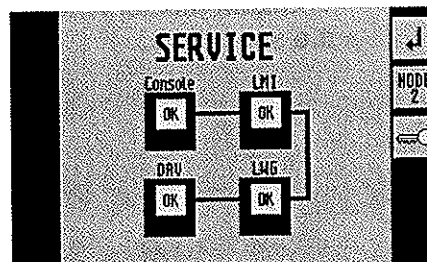

Brightness Setting Menu

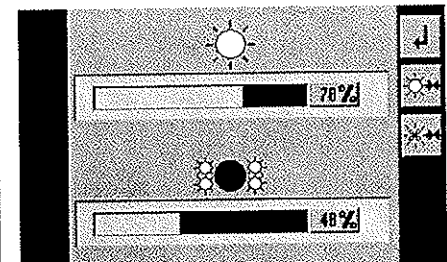

A detailed description of the symbols and displays can be found both in the individual chapters and in the Appendix to this manual.

(2) Utilization display (bar graph)

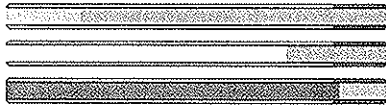

The *Utilization display (bar graph)* indicates how much of the permitted torque (nominal moment) is currently being utilized. The torque display also undergoes constant alteration because the nominal moment changes continuously during loader operation.

The bar graph is filled with various colors:

- green: "safe" range (0...90% of the nominal moment)
- yellow: "pre-warning" range (90...100% of the nominal moment)
- red: "overload range" (>100% of the nominal moment)

(3) "Load moment prewarning" light



This yellow prewarning light comes up when the load on the crane amounts to more than 90% of the respective nominal carrying load, which indicates that an overload situation is immediately pending.



For the crane operator, this means that the crane work can continue only with the greatest amount of caution.

(4) "Overload" warning light



This red *Overload warning light* indicates to the crane operator that an overload condition has occurred. It lights up when the crane load has reached 100% of maximum load carrying capacity permitted for the current operating status. The acoustic alarm sounds. The load-moment-increasing crane movements are switched off at the same time.

System Description

(5) "Hoist limit" warning light



This red warning light lights up when the hoist limit switch contacts open, i.e. when a hoist limit situation has occurred. The acoustic alarm sounds and load-moment-increasing crane movements are switched off at the same time.

NOTE

A hoist limit situation occurs when the hook block comes into contact with the boom head. The danger exists in such situations that the hoist rope will break, causing the load to fall. A hoist limit situation could arise from the load being pulled against the boom head or from the boom being extended or lowered without the hoist rope having been allowed to slacken.

(6) "Load limit device (LMI) override" warning light



This red warning light lights up when the switch-off function of the LMI system has been manually overridden.

(7) "Hoist limit switch (HES) override" warning light



This red warning light lights up when the switch-off function of the hoist limit switch has been manually overridden.

(8) "ESC (Escape)" key



Push button for returning to the normal LMI display

System Description

(9) "Brightness setting" pushbutton

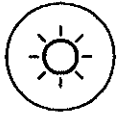

The brightness and thus the legibility of the data display and the buttons can be adjusted at any time with this pushbutton.

(10) "Buzzer off" key



The acoustic alarm can be suppressed by pressing this pushbutton, although not before the alarm has sounded a minimum of 5 s. The alarm will sound again after approximately 10 s if the cause of it being triggered is still present.

The acoustic alarm sounds in the following situations:

System test, overload condition, imminence of a hoist limit situation (when the hoist limit switch function is registered by the LMI system), disruption of the LMI system, or presence of operating errors recognized by the system.

(11) "Taring (TARE)" key



The "TARE" key is for the purpose of outputting the net load on the *Actual load display*. The net load is the current load minus the load hoisting equipment and the hook block. The "TARE" pushbutton must be pressed **before** the hoisting process is initiated.

After the button is actuated, the Current Load display is set to zero (tared). After the load has been raised, the Current Load display will then show the net load (payload). As soon as the working radius (by angle or radius modification) is modified, the display shows again the current load and the taring function is completed.

Note: The current load includes the hook block, the hoist rope and all of the load lifting tackle. The net load is the current load on the hook without load lifting tackle. Display errors can be caused by the effects of environmental influences such as wind on the boom or the load.

System Description

(12) Rotary selection wheel with pushbutton

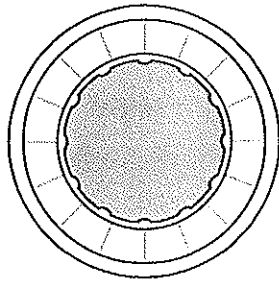

This central rotary selection wheel is used to navigate within the menu structure.

At first **select** the desired soft key symbol .

By **pressing** the button of the rotary wheel the marked function is carried out.

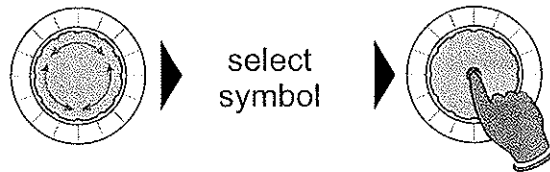

▼ LMI main screen (1st level of function keys)

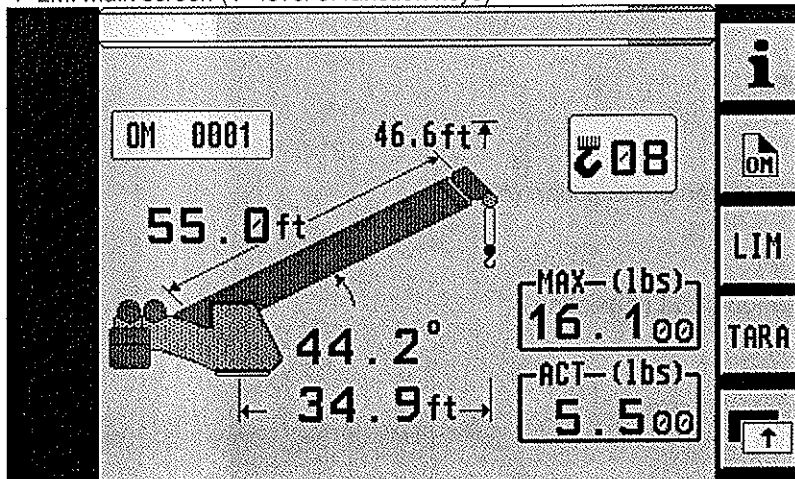





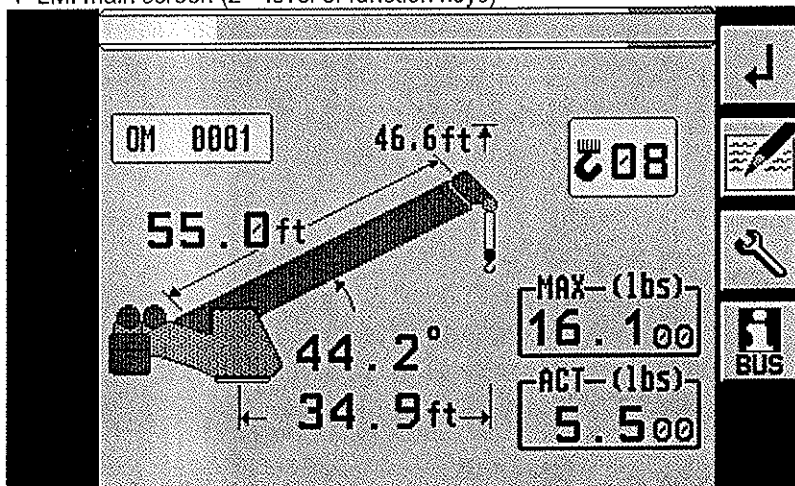



- < show info screens
- < start operation mode setup
- < set geometrical limits
- < start TARE function
- < switch to 2nd level of function keys

▼ LMI main screen (2nd level of function keys)



- < back to the previous menu
- < show LMI value screen
- < show service menu
- < show CAN-bus menu

3.4. Description of the status symbols

	"LMI" overridden
	LMI error (in connection with fault code)
	Excavating operation, LMI overridden
	Excavating operation, safety alert symbol
	Bus error
	Number of reeving
	Hoist limit switch has come into action (A2B)
	A-frame pressure too great (if existing)

System Description

Upon request, further symbols may appear on the display:



Symbol **Anti Two-Block Alarm**

- visible when the anti-two-block limit switch contacts open, indicating that a two-blocking condition is approaching.



Symbol **radius limitation**

- continuously visible:
radius limitation active
- blinking:
range limits exceeded
(⇒ see chapter 4.3.1)



Symbol **height limitation:**

- continuously visible:
height limitation active
- blinking:
height limit exceeded
(⇒ see chapter 4.3.2)



Symbol **boom angle limitation:**

- continuously visible:
boom angle limitation active
- blinking:
angle limits exceeded
(⇒ see chapter 4.3.3)



Symbol **slewing angle limitation:**

- continuously visible:
slewing angle limitation active
- blinking:
slewing angle limits exceeded
(⇒ see chapter 4.3.4.1)



Symbol **work area definition:**

- continuously visible:
work area definition active
- blinking:
work area limits exceeded
(⇒ see chapter 4.3.4.2)

E # #

Error code No. ##

(⇒ see chapter 7 "Troubleshooting")

4. Configuration SETUP

The LMI setup procedure allows the operator to input the crane configuration using interactive displays. The operator must complete the setup procedure for the Load Moment Indicator system if the system has been turned off for more than two hours or the crane operation configuration has been changed.



The LMI cannot perform correctly unless it has been properly adjusted. The prerequisite for this is making conscientious and correct entries during the set-up procedure, in accordance with the actual configuration of the crane. The correctness of the LMI settings must be ensured before beginning crane work in order to avoid damage to property and severe or even fatal injuries to personnel.

LMI Setup Procedure

- ...starts:**
 - *automatically*, if the system was turned off for more than two hours.
 - needs to start *manually* at each modification of the crane configuration by selecting soft function key  and pressing rotary wheel (12)
- ...is operated:**
 - by answering the different pictorial questions using functional keys in accordance with the actual configuration of the crane.
- ...is cancelled:**
 - any time by pressing again key (8) "ESC". The system, however, is only ready for operation, if the procedure has been **completed** and the inputs have been **confirmed**.

If the system is turned off, for example during short breaks (less than 2 hours), all adjustments remain stored. When turning on again the system these adjustments can be acknowledged by merely pressing one key (provided that the crane configuration has not been modified!).

During the programming procedure the Load Moment Prewarning Light (3) and the Load Moment Limit Light (4) will light up and the aggravating crane movements will be interrupted.

The LMI programming procedure consists of the following steps (interactive operation):

- setting the boom type configuration
- specify jib / selecting the pick point / stowed jib operation
- setting the outrigger configuration
- setting the hoist
- setting the reevings
- confirmation of the programming procedure

For easy operation, the computer guides the operator through the procedure step by step.

Programming

4.1 Interactive operating mode setup

It is necessary to setup the system by entering the respective mode of operation every time the crane structure is modified.

The system will temporarily interrupt the movements of the crane during the programming procedure.



WARNING

The correct setting is of utmost importance for the proper functioning of the system and the crane. Therefore, only operators who are thoroughly familiar with the crane and the operation of the system should execute the setting of the system according to the operating configuration of the crane.

Calling up the function:

Automatic with system restart (system shut down longer than 2 hours)

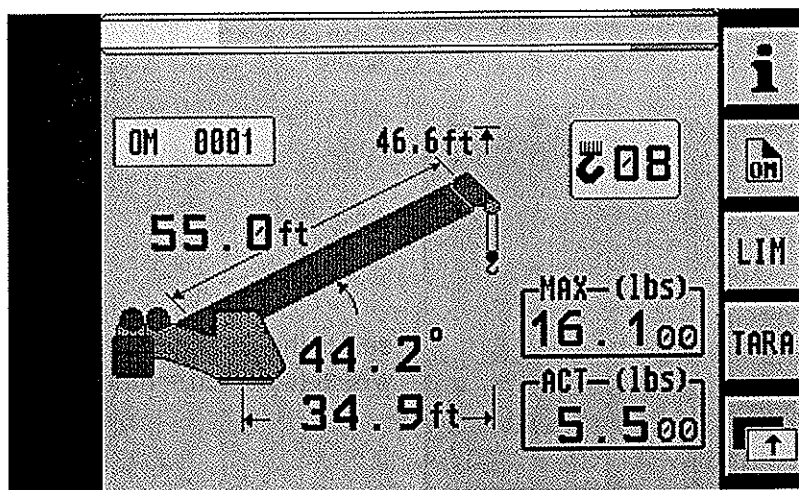
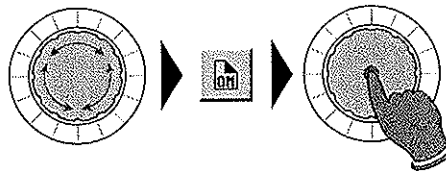
or by selecting the soft function key  and actuating the rotary wheel button (from the LMI screen)



< Start operation mode setup

Programming

Start of configuration setup menu:

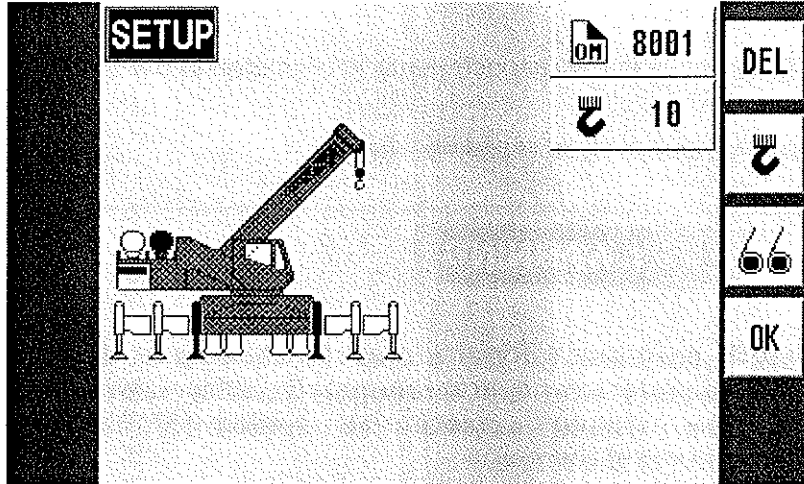

< DELETE entries, renew setup

Quick change reevings

Quick change hoist selection

OK, all entries are correct

Setting the boom type configuration:

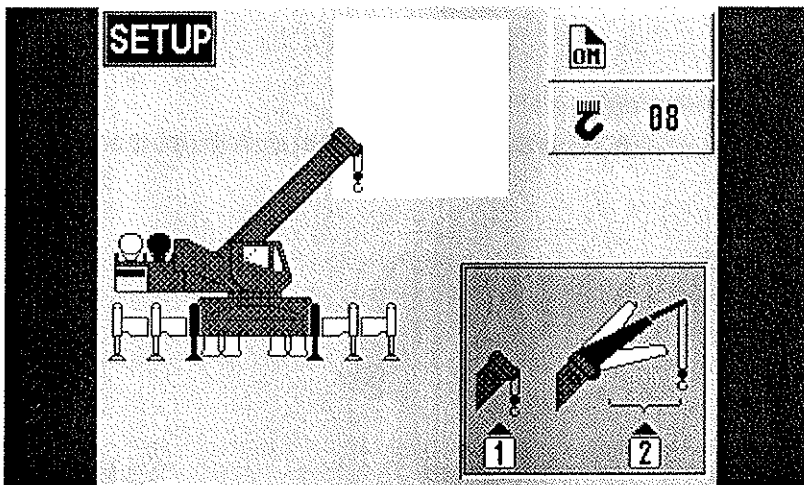

select the boom type with the rotary wheel (selected = marked yellow)

Select jib angle:

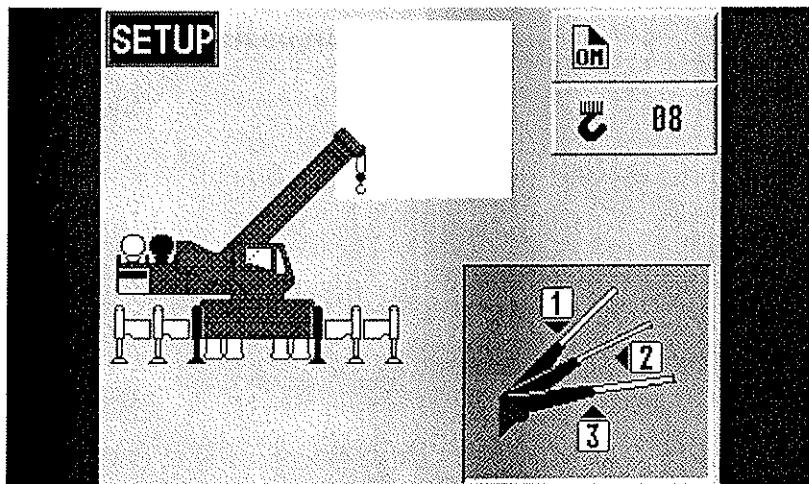

select the jib angle with the rotary wheel (selected = marked yellow)

Programming

Select pick point:

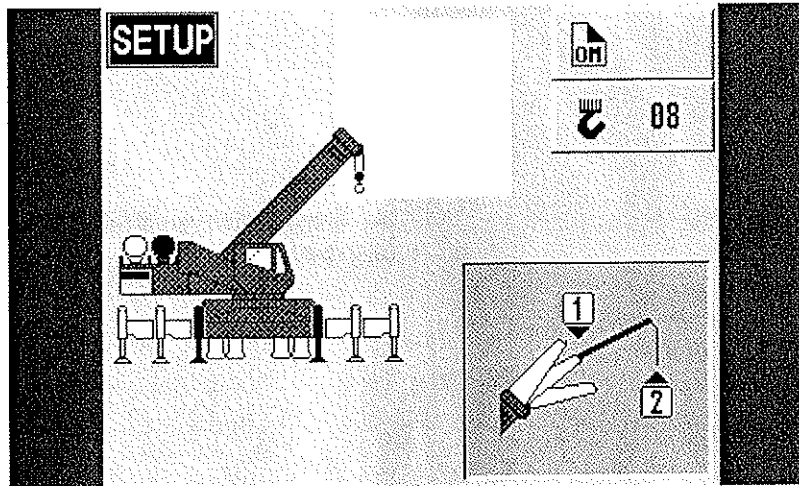

select the pick point with the rotary wheel (selected = marked yellow)

Select outrigger configuration:

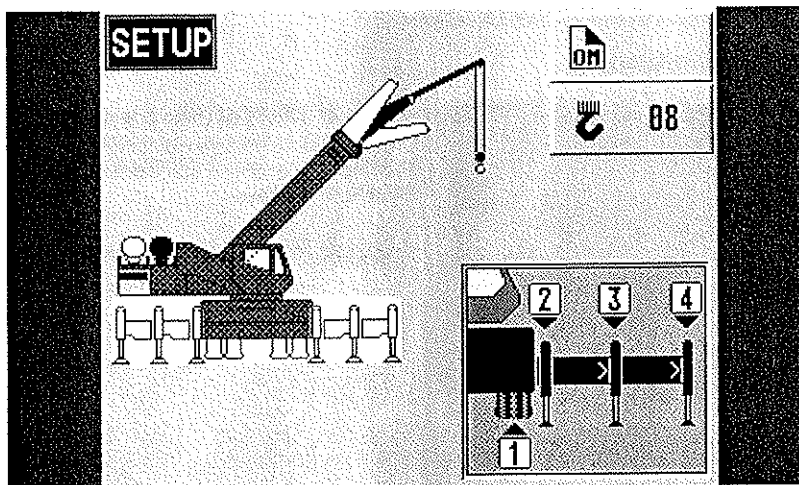

select the jib angle with the rotary wheel (selected = marked yellow)

Select hoist:

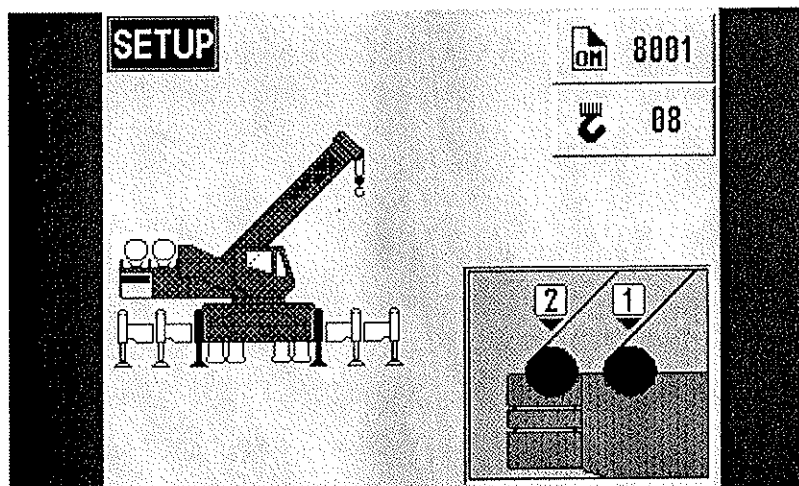

select the hoist with the rotary wheel (selected = marked yellow)

Programming

Input reeving:

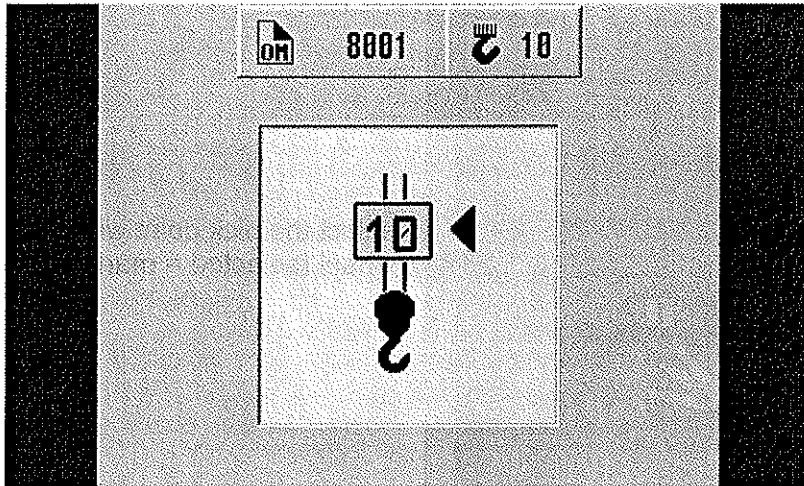

Input the number of falls (reevings) with the rotary wheel

Confirmation screen:

In this menu screen, the operator is prompted to confirm the entries once again.

Check the displayed values before confirming them!

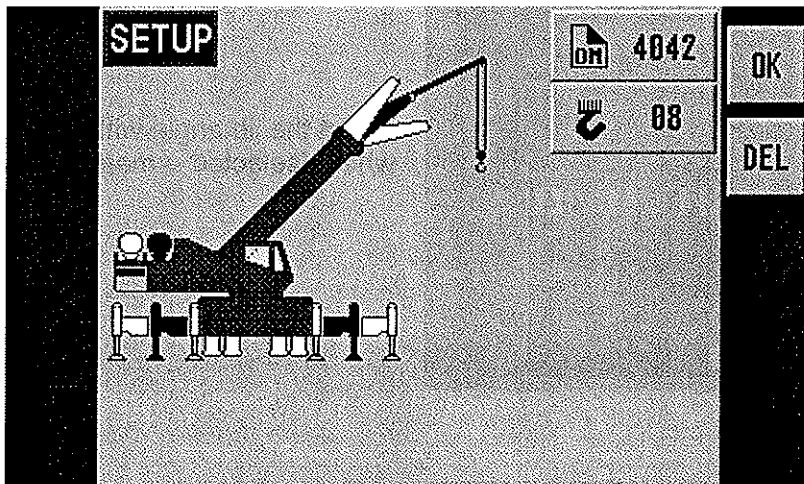

< OK, if all entries are correct

The entering of the mode of operation code is completed after this confirmation, and the crane menu is displayed.

< DELETE entries, renew setup

Programming

4.2 Quick adjusting the rope reeving or selecting the hoist

It is necessary to program the system by entering the respective number of reevings each time the rope reeving arrangement is modified.

The system will temporarily interrupt the movements of the crane during the programming procedure.

Calling up the function:

By selecting the the soft function key  and actuating the rotary wheel button (from the LMI screen)

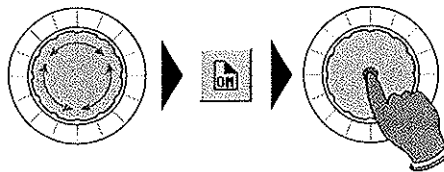

Start of configuration setup menu:

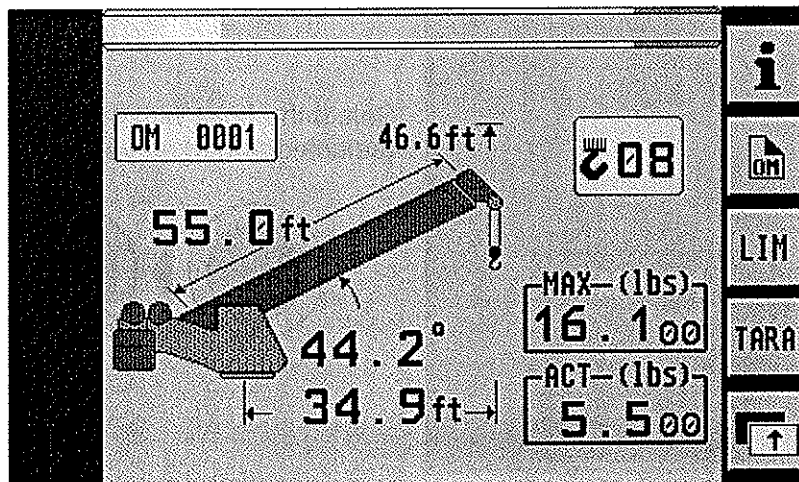

< Start operation mode setup

Start reeving menu:

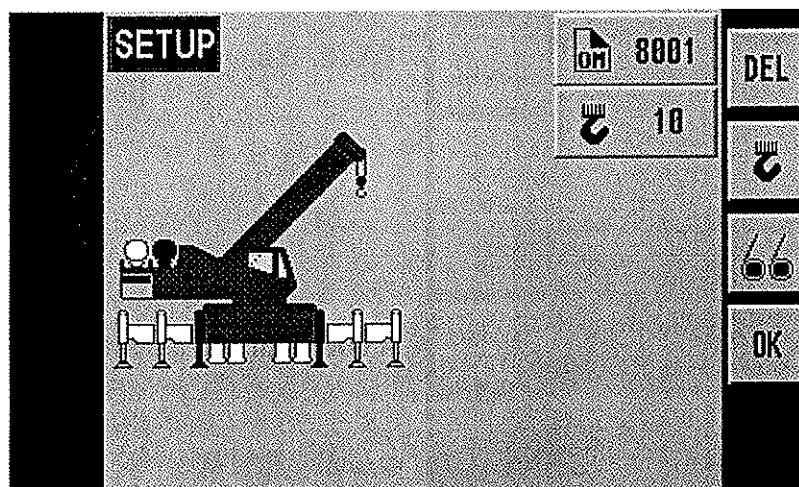

DELETE entries, renew setup

< Quick change reevings

< Quick change hoist selection

OK. if all entries are correct

Programming

Input reeving:

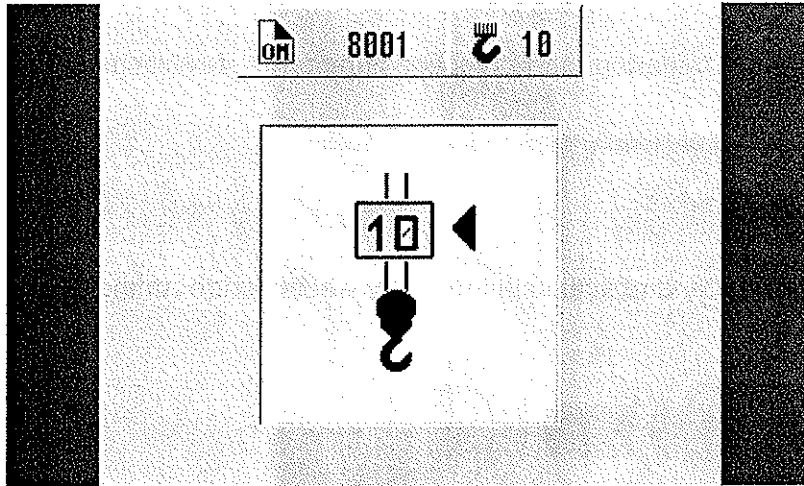

Input the number of falls (reevings) with the rotary wheel:

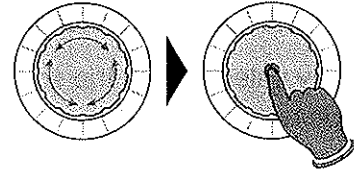

or select hoist:

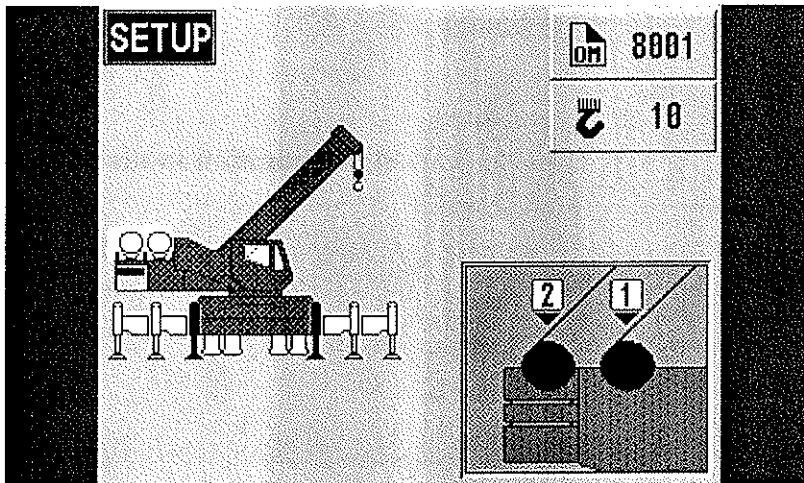

Select the hoist with the rotary wheel (selected = marked yellow)

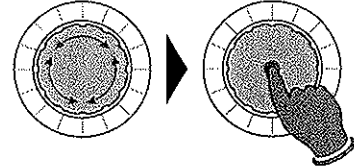

Overview menu is displayed again:

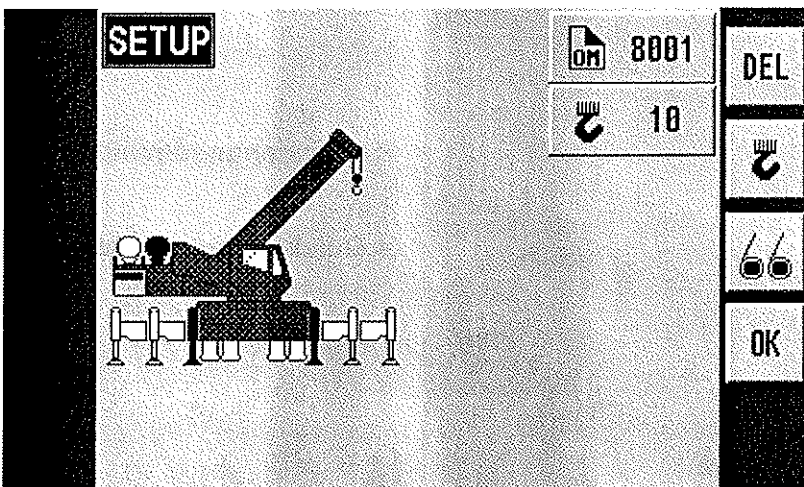

DELETE entries, renew setup

< OK, if all entries are correct

Programming

Confirmation screen:

In this menu screen, the operator is prompted to confirm the entries once again.
Check the displayed values before confirming them!

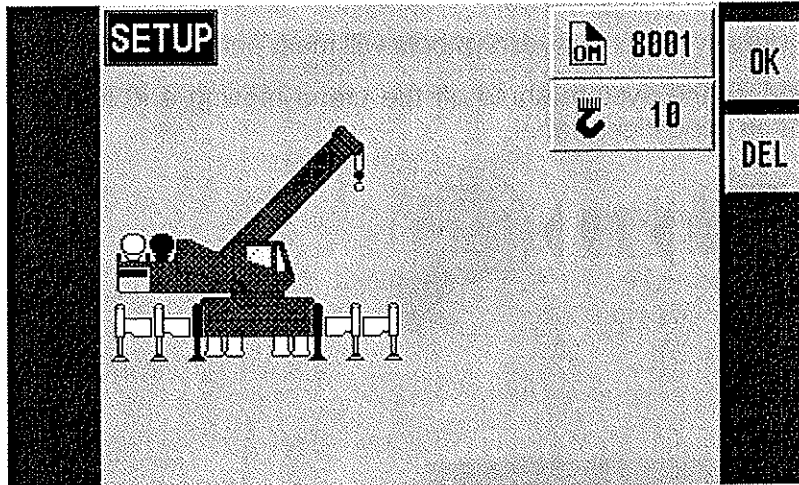

< OK, if all entries are correct

The entering of the mode of operation code is completed after this confirmation, and the crane menu is displayed.

< DELETE entries, renew setup

4.3 Programming geometrical limitations

The LMI system comprises programmed limit entries for the operating range of the crane. Programming easily is facilitated by interactive step-by-step guidance.

- The functions can be used individually or combined. Symbols will mark active limitations.
- If a programmed limit is exceeded, the system shuts off the crane moving and triggers a visual indication (blinking symbol) and an acoustical signal.

Calling up the function:

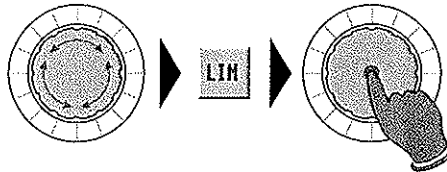

Start of configuration setup menu:

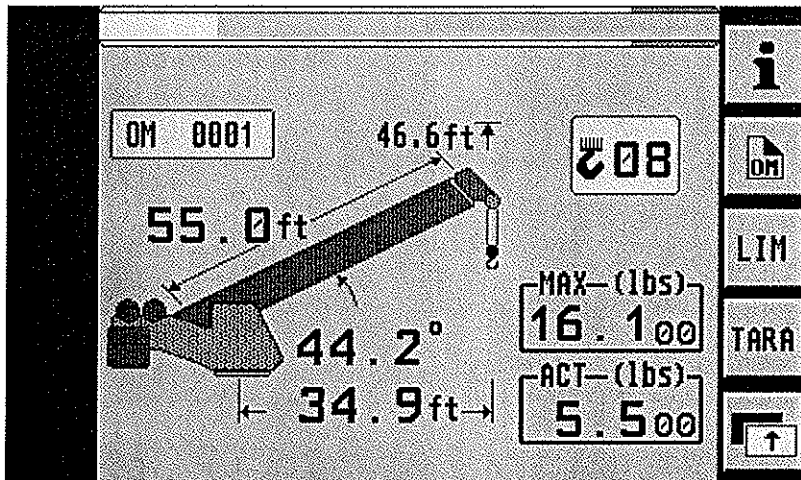

< Start limits menu

Start of configuration setup menu:

back to normal LMI working screen	
edit radius limit	chapter: > 4.3.1
edit height limit	> 4.3.2
edit main boom angle limit	> 4.3.3
edit slewing angle limit / virtual wall	> 4.3.4

Programming

4.3.1 Radius Limitation

Programmable function to limit the minimum and/or the maximum boom radius

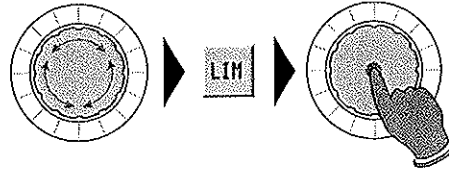

Calling up the function:

	back to normal LMI working screen
	edit radius limit
	edit tip height limit
	edit main boom angle limit
	edit slewing angle limit / virtual wall

Example: Programming of the minimum radius limit. Programming of the maximum radius limit is comparable.

	back to limits main menu
	store actual boom position as minimum radius limit
	switch minimum radius limit on/off
	store actual boom position as maximum radius limit
	switch maximum radius limit on/off

>>

Programming

		back to limits main menu
		store actual boom position as minimum radius limit
		switch minimum radius limit on/off
		store actual boom position as maximum radius limit
		switch maximum radius limit on/off

After limitation is switched on, the limit value and the respective status symbol appears. The symbol will blink, if one limit value is reached or exceeded:

		back to limits main menu
		store actual boom position as minimum radius limit
		switch minimum radius limit on/off
		store actual boom position as maximum radius limit
		switch maximum radius limit on/off

Programming

4.3.2 Tip Height Limitation

Programmable function for the limitation of the tip height

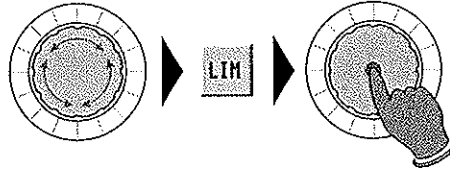

Calling up the function:

	<ul style="list-style-type: none"> back to normal LMI working screen edit radius limit edit tip height limit edit main boom angle limit edit slewing angle limit / virtual wall
	<ul style="list-style-type: none"> back to limits main menu switch left limit on/off store actual boom tip height as maximum height limit

>>

Programming

	back to limits main menu
	switch height limit on/off
	store actual boom tip height as maximum height limit

After limitation is switched on, the limit value and the respective status symbol appears. The symbol will blink, if one limit value is reached or exceeded:

	back to limits main menu
	Switch height limit on/off
	store actual boom tip height as maximum height limit

Programming

4.3.3 Boom Angle Limitation

Programmable function to limit the minimum and/or the maximum boom radius.

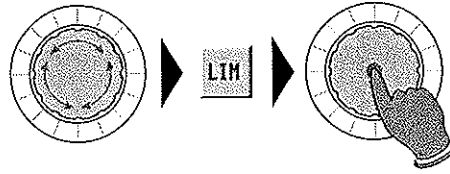

Calling up the function:

		back to normal LMI working screen
		edit radius limit
		edit tip height limit
		edit main boom angle limit
		edit slewing angle limit / virtual wall

Example: Programming of the minimum boom angle limit. Programming of the maximum boom angle limit is comparable.

		back to limits main menu
		store actual boom position as maximum boom angle limit
		switch maximum angle limit on/off
		store actual boom position as minimum boom angle limit
		switch minimum angle limit on/off

>>

Programming

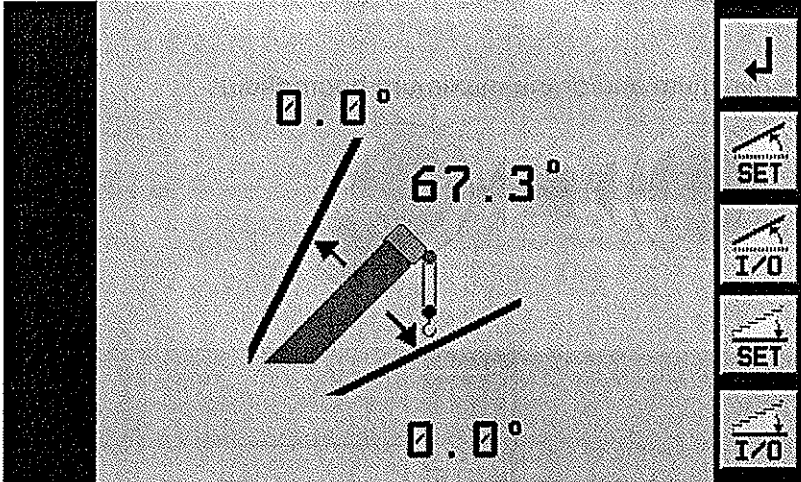
	back to limits main menu
	store actual boom position as maximum boom angle limit
	switch maximum angle limit on/off
	store actual boom position as minimum boom angle limit
	switch minimum angle limit on/off

After limitation is switched on, the limit value and the respective status symbol appears. The symbol will blink, if one limit value is reached or exceeded.

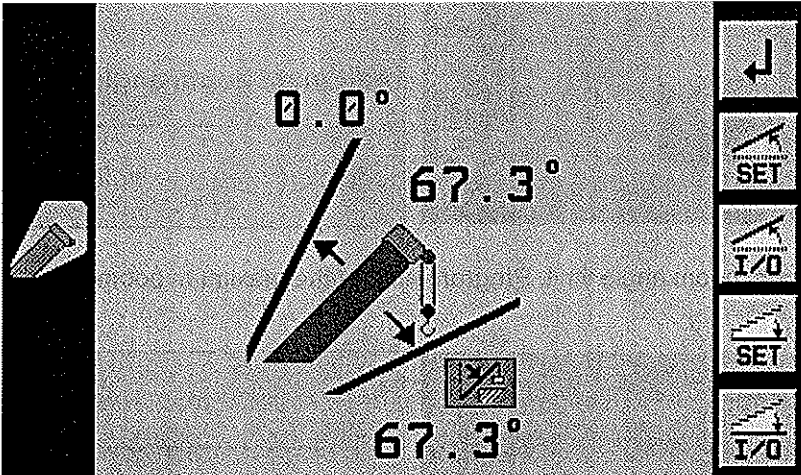
	back to limits main menu
	store actual boom position as maximum boom angle limit
	switch maximum angle limit on/off
	store actual boom position as minimum boom angle limit
	switch minimum angle limit on/off

Programming

4.3.4 Slewing Angle Limitation / Virtual Wall Definition

4.3.4.1 Slewing Angle Limitation

Programmable function for the limitation of the left and/or right slewing angle.

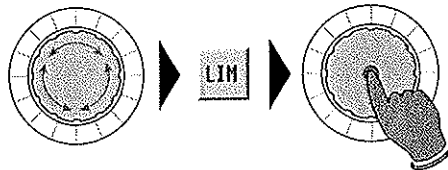

Calling up the function:

		<table border="1"> <tr><td>back to normal LMI working screen</td></tr> <tr><td>edit radius limit</td></tr> <tr><td>edit tip height limit</td></tr> <tr><td>edit main boom angle limit</td></tr> <tr><td>edit slewing angle limit / virtual wall</td></tr> </table>	back to normal LMI working screen	edit radius limit	edit tip height limit	edit main boom angle limit	edit slewing angle limit / virtual wall
back to normal LMI working screen							
edit radius limit							
edit tip height limit							
edit main boom angle limit							
edit slewing angle limit / virtual wall							
		<table border="1"> <tr><td>back to limits main menu</td></tr> <tr><td>edit slewing angle limit</td></tr> <tr><td>edit virtual walls</td></tr> <tr><td> </td></tr> <tr><td> </td></tr> </table>	back to limits main menu	edit slewing angle limit	edit virtual walls		
back to limits main menu							
edit slewing angle limit							
edit virtual walls							

>>

Programming

Example: Programming of the left slewing angle limit.
Programming of the right slewing angle limit is comparable.

The screenshot shows a crane icon with a central vertical line. Two curved arrows indicate the slewing range. The top arrow is labeled 52.1° . Below the crane, two digital displays show 0.0° on the left and 0.0° on the right. To the right of the crane is a vertical menu with five buttons: a back arrow, a SET button with a crane icon, an I/O button with a crane icon, another SET button with a crane icon, and another I/O button with a crane icon.

	back to limits main menu
	store actual boom position as left slewing angle limit
	switch left limit on/off
	store actual boom position as right slewing angle limit
	switch right limit on/off

The screenshot is identical to the previous one, but the left 52.1° value is highlighted with a thick black border. The menu buttons are the same.

	back to limits main menu
	store actual boom position as left slewing angle limit
	switch left limit on/off
	store actual boom position as right slewing angle limit
	switch right limit on/off

When limitation is switched on, the limit value and the respective status symbol appears. The symbol will blink, if one limit value is reached or exceeded.

The screenshot is identical to the previous one, but a small square status symbol with a crane icon and a diagonal line is now visible next to the left 52.1° value. The menu buttons are the same.

	back to limits main menu
	store actual boom position as left slewing angle limit
	switch left limit on/off
	store actual boom position as right slewing angle limit
	switch right limit on/off

4.3.4.2 Working Area Limitation (Virtual Wall)

Programmable function for the limitation of the working area by up to 5 virtual walls.

The work area definition system helps the operator to define the crane's working area. This is done by creating vertical wall(s) that can represent obstacles (i.e. buildings, towers, poles, etc.) in the crane's working range. The wall(s) are set by defining points with the boom tip along the outer limits of the operator's work area, see setup procedure below. Because these walls are defined by the operator and are not "actual real" walls, we refer to them as "virtual" walls. When setting the walls, always keep a safe working distance to any obstacles. Never work outside a safe working area as outlined by common practice, standards, and manuals. A virtual wall is set by defining two points.

To prevent inaccuracies when defining the two points for the virtual wall, use the following to rules:

1. The two points should be the same distance form the obstacle.
2. Set the two points at the maximum distance apart, which can be safely reached by the boom tip.

The operator can setup up to 5 virtual walls, the first wall is defined by a straight line between two set points. The second through fifth walls are created by one new point and the previously selected point. After the walls have been set, the system alerts the operator and when the boom approaches them. This is done both visual and audible. Similarly, the "virtual wall" symbol in the main screen blinks.

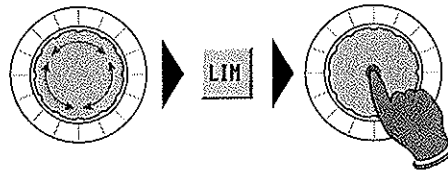

Calling up the function:

	back to normal LMI working screen
	edit radius limit
	edit tip height limit
	edit main boom angle limit
	edit slewing angle limit / virtual wall

>>

Programming

	back to limits main menu
	edit slewing angle limit
	edit virtual walls

	back to previous menu
	set a point in the working area to start a wall having pressed SET, the point is marked by "X"
	delete existing walls

	back to previous menu
	move the boom tip to an other point set the second point in the working area to create a wall
	delete existing walls

When second point of the virtual wall is set, the wall is displayed and the respective status symbol appears. The symbol will blink, if the virtual wall is reached or exceeded.

>>

Programming

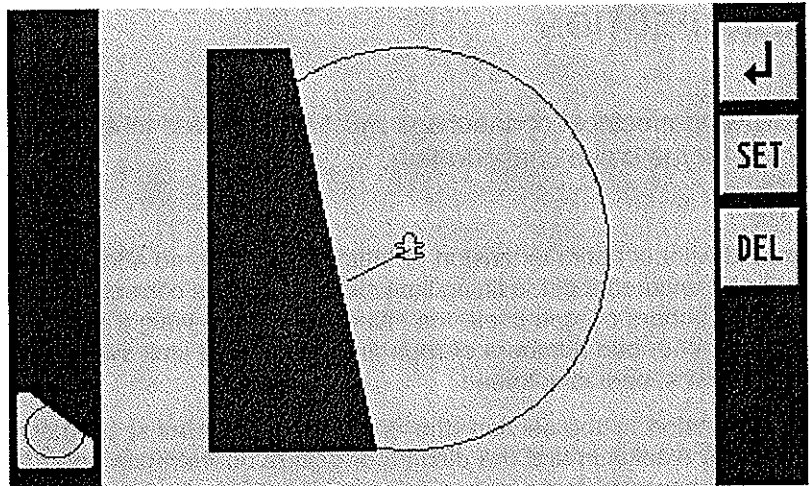

↩	back to main limit menu
SET	allows for further walls to be added (up to 5 virtual walls)
DEL	delete all existing walls

Example with 4 virtual walls:

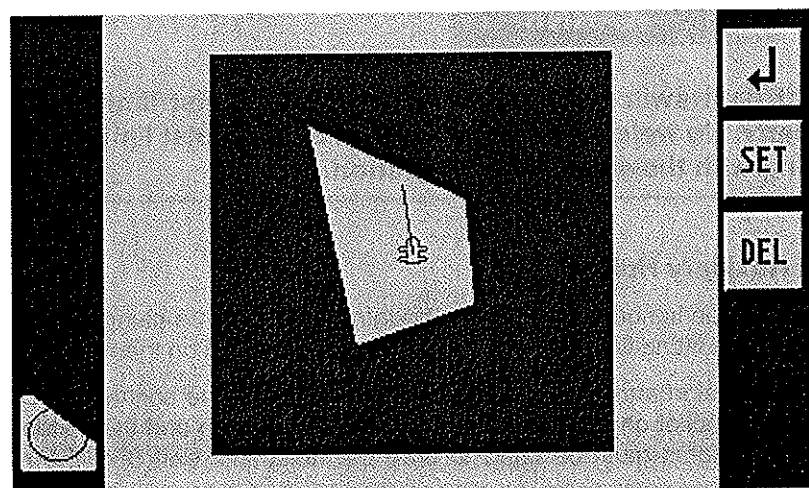

↩	back to main limit menu
SET	allows for further walls to be added (up to 5 virtual walls)
DEL	delete all existing walls

Inspection checks before going into operation

5. PRE-OPERATIONAL INSPECTION

Prior to operating the crane, the following electrical connections must be checked to ensure that the LMI system is properly connected for the crane configuration.

- **Cranes with only a main hoist**

If the crane works only with the boom and without boom extension or lattice extension, no additional connections are necessary. It must however be ensured that the lifting limit switch weight is correctly mounted on the main boom hoist rope. With even numbers of rope lines, the lifting limit switch weight shall be attached to the "dead end" of the hoist rope. With odd numbers of rope lines, the lifting limit switch weight shall be attached to the rope line with the lowest operating speed.

If the crane works with a main boom extension or top section, the connecting cable must be mounted between the distributor socket on the lattice extension and the distributor socket on the main boom. The weight of the hoist limit switch of the main boom must be disconnected and mounted on the hoist limit switch of the extension or of the fly boom.



Failure to reposition the hoist limit switch weight will prevent the hoist limit switch system from functioning properly. No weight shall be mounted on the hoist limit switch of the main boom when working with the extension/top section.

- **Machines with Main and Auxiliary Hoists**

If the main boom extension or the top section is not used, then the bridging plug must be plugged into the distributor socket on the main boom and the lifting limit switch weight must be mounted on the main boom.

If the crane works with a main boom extension and/or with a lattice extension, then the connecting cable must be mounted between the distributor socket on the extension or on the top section and the distributor socket on the main boom. In addition, weights must be fitted to both the hoist limit switch of the main boom and the extension or the top section.

If the boom extension or the lattice extension are in working position and if the main boom is not equipped with a hoist rope, then the weight of the hoist limit switch on the main boom must be removed in order to prevent endangerment to personnel or damage to the equipment.

After the electrical connections have been checked to ensure that the system is properly connected for the respective crane configuration, the following checks must be made:

1. Check the electrical wiring connecting the various parts of the system for physical damage.
2. Check the hoist limit switches and hoist limit weights for free movement.
3. Inspection of the spring cable drum for smooth running, initial drum tension and correct winding of the cable.
4. Inspection of the mechanical and electrical installation of power measurement sockets on the lattice extensions (if present).

Inspection checks before going into operation

 **WARNING**

The following tests must be performed with care in order to avoid damage to the crane or injury to personnel. Proper functioning of the LMI system requires successful completion of these tests before commencing work. If the operator cannot see the hook block approaching the pulley head, he must assign this task to an assistant (slinger). The crane operator must be prepared to stop the crane at once in the event that the LMI system is not working correctly, i.e. when the red warning lights fail to light up, the acoustic alarm does not sound and the crane movements such as raising, extending and luffing are not switched off.

Check the *Hoist limit switch warning light* and the acoustic alarm as follows:

1. Manually raise the weight fitted on the hoist limit switch. As soon as the weight is raised, the acoustic alarm should sound and the *hoist limit switch warning light* should light up.
2. Using the main hoist, pull the hook block slowly against the lifting limit switch weight. As soon as the hook block raises the weight, the acoustic alarm should be triggered, the *hoist limit switch warning light* should light up and the main hoist should switch off. Lower the hook block somewhat to eliminate this condition.
3. Slowly lower the boom to bring about a potential hoist limit situation. As soon as the hook block raises the weight, the acoustic alarm should sound, the *hoist limit switch warning light* should light up and the luffing gear should switch off. Lower the hook block somewhat to eliminate this condition.
4. Slowly extend (telescope out) the boom to bring about a potential hoist limit situation. As soon as the hook block raises the weight, the acoustic alarm should sound, the *hoist limit switch warning light* should light up and the telescoping function should switch off. Lower the hook block somewhat to eliminate this condition.

 **WARNING**

If the warning light and the audible alarm do not function as described and the crane movements are not switched off, then the system is not working properly. The malfunction must be corrected before commencing work.

5. If the crane is equipped with a main boom extension or with a lattice extension, then the inspection procedure must be repeated for the hoist limit switch of the extension/top section.
6. Check that the display of the main boom length agrees with the actual boom length.
7. Check that the display of the main boom angle agrees with the actual boom angles.
8. Check that the display of the operating radius of the crane agrees with the actual radius.
9. Check the load display by lifting a load of known weight. The accuracy of the load display must be within the tolerance range.

Inspection checks before going into operation

5.1 OPERATION

The LMI is operational once it has been adjusted properly. The crane operator must for that reason be familiar with all of the operating elements of the LMI and must make the correct entries before the crane begins work. The proper function of the system shall be checked by lifting a load of known weight and comparing the load to the information displayed on the LMI.

Rated loads include the weight of the hook block, slings, and auxiliary load handling devices. This combined weight must be subtracted from the values contained in the load capacity chart in order to determine the net load to be raised.



If any of the displays reflect a deviation between displayed and actual values an authorized PAT service representative shall be called for repair of the system or re-verification of the crane's LMI calibration.

Contact: www.hirschmann-ac.de



Any structural modifications or changes to the crane shall require re-verification of the crane's LMI calibration.

6. SERVICE AND MAINTENANCE

Daily maintenance of the load moment limitation system consists of inspecting:

1. The electrical wiring connecting the various parts of the system.
If a cable is damaged, then it must be replaced immediately.
2. The insulation of the length indicator rope and/or hoist limit switch cable and of the cable guides. If the insulation or the cable guides are damaged, then these parts should be replaced immediately.
3. Checking the hoist limit switches for ease of movement.
4. Inspection of the cable drums to check for sufficient prestressing.
5. Checking the pressure absorbers on the lift cylinders and the connecting hoses for oil leakage.



Personnel who are not specially trained may rectify only those malfunctions listed in the Malfunction Table, but they are not permitted to replace any defective mechanical parts or cables.

6.1 Information / Service Menus

The system contains different menus in which system information can be displayed.

In addition, adjustments can also be made in several Service Menus that have an effect on system behavior. Access to these menus is protected by an access code.

The system will temporarily interrupt the movements of the crane during the call-up procedure. In addition, the warning lights (3), (4) and (5) will light up.

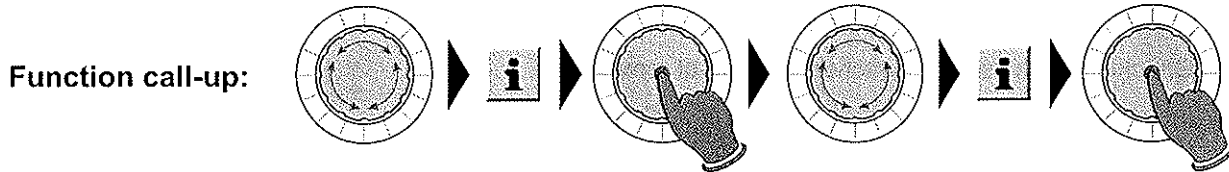

Info sensor values:

Info				↓	back to the previous menu
	raw	mV	phys	🔑	to calibration menus (service) (access is code protected)
piston	22.9	1417	69.5	Header	to info node1 / node 2
rod	3.1	623	9.2		
angle	37.6	500	56.15		
length	0.0	2004	9.85		
sl.ang	40.7	2127	-73.43		
sl.ang	8.5	840			

Info node 1 (expert compact):

Mode: 1	↓	back to the previous menu
PAT-PDC D4 DISPLAY System Software - V 2.61- (c) 1990-2007 HAC GmbH Ettlin gen	⬇	scroll down next screen
I/O-configuration MQVGA - V1.00 HAC G mbH - (c) 16.11.2006	⬆	scroll up next screen
CAN mapping n1v003 Grove LMI with iF lex2-System		
Grafik: Grove RT 530 expert compact -		

Service and Maintenance

Info node 2 (iFLEX2):

<pre> Node: 2 PAT-PDC iFLEX2 System Software - V 2. 60- (c) 2005-2007 HAC GmbH Ettlingen ----- I/O-configuration PAT dp - V1.00 PAT GmbH - (c) ----- CAN mapping n2v003 Grove LMI with iF lex2-System ----- iflex2 C LMB Software - LSQG V1.03/20 070411 - (c) HAC GmbH </pre>		<p>back to the previous menu</p> <hr/> <p>scroll down next screen</p> <hr/> <p>scroll up next screen</p> <hr/>
--	---	--

Navigation through the Information and Service Menus sector can be found in the Appendix

7. TROUBLESHOOTING

7.1 General

In the event of a malfunction or an operating error recognized by the system, codes will be displayed in the status field of the *Data display* (1) which specify the reason for the malfunction:

Error in the LMI system:



Error in the control system:



The error codes listed in the following Malfunction Table will identify various faults which can occur with this system. Malfunctions in the LMI System which were caused by exceeding the prescribed ranges or by operating errors on the part of the crane operator can normally be rectified by the crane operator himself. Errors in the microprocessor system **may only** be rectified by factory-trained Customer Service personnel.

Contact Hirschmann Customer Service if this occurs.

> www.hirschmann-ac.com > ELECTRONIC CONTROL SYSTEMS > Service & Support

7.2 LMI System Malfunction Table (LSQG V 1.xx)

Fault code	Error	Cause	Elimination
E01	Fallen below radius range or angle range exceeded	<ul style="list-style-type: none"> • Fallen below the minimum radius or gone past the maximum angle specified in the respective load chart due to luffing up the boom too far 	<ul style="list-style-type: none"> • Luff down the boom to a radius or angle specified in the load chart.
E02	Radius range exceeded or fallen below angle range	<ul style="list-style-type: none"> • Gone past the maximum radius or fallen below the minimum angle specified in the respective load chart due to luffing down the boom too far 	<ul style="list-style-type: none"> • Luff up the boom to a radius or angle specified in the load chart.
E03	Non-permitted slewing zone (no load area)	<ul style="list-style-type: none"> • The slewing zone with load is not permitted 	<ul style="list-style-type: none"> • Slew to permitted area
E04	Operating mode not acknowledged or non permitted slewing zone	<ul style="list-style-type: none"> • A non existing operating mode has been selected 	<ul style="list-style-type: none"> • Set the correct operating mode for the operating state in question
		<ul style="list-style-type: none"> • The boom is in a non-permitted slewing zone 	<ul style="list-style-type: none"> • Slew the boom to a permitted area.
E05	Prohibited length range	<ul style="list-style-type: none"> • Boom has been extended either too far or not far enough, e.g. if it is prohibited to go beyond a certain maximum boom length or with load curves for jibs where the main boom has to be extended to a certain length 	<ul style="list-style-type: none"> • Extend/retract boom to the correct length
		<ul style="list-style-type: none"> • Length sensor adjustment has changed, e.g. the cable slid off the length sensor reel. 	<ul style="list-style-type: none"> • Retract boom. Check the prestress of the cable reel (cable must be taut). Open the length sensor and carefully turn the length sensor pot counter-clockwise until the detent by means of a screw driver
		<ul style="list-style-type: none"> • Clutch between length sensor pot and drive is defective 	<ul style="list-style-type: none"> • Replace the complete clutch including drive wheel and adjust length sensor pot as described above
E06	Radius range exceeded or fallen below angle range with luffing jib operation	<ul style="list-style-type: none"> • Maximum radius as specified in the load chart exceeded or fallen below minimum angle due to luffing down the luffing jib too far 	<ul style="list-style-type: none"> • Luff the jib to a radius or angle specified in the load chart.
E11	Fallen below lower limit value for measuring channel "length main boom"	<ul style="list-style-type: none"> • Length potentiometer is defective • PDB variable for analog value not supported 	<ul style="list-style-type: none"> • Replace length potentiometer • Setup of correct PDB variable for analog value in DGA6.i.3
		<ul style="list-style-type: none"> • Electronic component in the measuring channel is defective 	<ul style="list-style-type: none"> • Replace sensor unit
E12	Fallen below the lower limit value in the measuring channel "pressure piston side"	<ul style="list-style-type: none"> • Pressure transducer is defective. • PDB variable for analog value not supported 	<ul style="list-style-type: none"> • Replace pressure transducer • Setup of correct PDB variable for analog value in DGA6.i.3

Troubleshooting

Fault code	Error	Cause	Elimination
		<ul style="list-style-type: none"> Electronic component in the measuring channel is defective. 	<ul style="list-style-type: none"> Replace sensor unit
E13	Fallen below lower limit value in the measuring channel "pressure rod side"	<ul style="list-style-type: none"> refer to E12 	<ul style="list-style-type: none"> refer to E12
E14	Fallen below lower limit value in measuring channel "force"	<ul style="list-style-type: none"> Force transducer defective Electronic component in the measuring channel is defective. 	<ul style="list-style-type: none"> Replace force transducer Replace sensor unit
E15	Fallen below lower limit value in measuring channel "angle main boom"	<ul style="list-style-type: none"> Angle potentiometer defective PDB variable for analog value not supported 	<ul style="list-style-type: none"> Replace angle sensor Setup of correct PDB variable for analog value in DGA6.i.3
		<ul style="list-style-type: none"> Electronic component in the measuring channel defective. 	<ul style="list-style-type: none"> Replace sensor unit
E16	Fallen below lower limit value in measuring channel "angle 2"	<ul style="list-style-type: none"> Angle potentiometer defective 	<ul style="list-style-type: none"> Replace angle sensor
		<ul style="list-style-type: none"> Electronic component in the measuring channel defective. 	<ul style="list-style-type: none"> Replace sensor unit
E17	Fallen below lower limit value "length telescope I (+II)"	<ul style="list-style-type: none"> Length potentiometer defective 	<ul style="list-style-type: none"> Replace length sensor.
		<ul style="list-style-type: none"> Electronic component in the measuring channel defective 	<ul style="list-style-type: none"> Replace sensor unit
E18	Front outrigger overloaded	<ul style="list-style-type: none"> Front outrigger overloaded 	<ul style="list-style-type: none">
E1A	Fallen below lower limit value in measuring channel "slewing angle 1". slew below allowed range	<ul style="list-style-type: none"> Cable between the central unit and the slewing angle sensor defective or loose. Water inside the plug of the angle sensor 	<ul style="list-style-type: none"> Check cable as well as plugs, replace, if need be.
		<ul style="list-style-type: none"> 1-cannel slew sensor min. value DGA 11.5.7 <> 0 	<ul style="list-style-type: none"> move to allowed slew range
		<ul style="list-style-type: none"> Slewing angle potentiometer is defective 	<ul style="list-style-type: none"> Replace slewing angle sensor
		<ul style="list-style-type: none"> Electronic component in the measuring channel defective 	<ul style="list-style-type: none"> Replace sensor unit
E1B	Fallen below lower limit value in measuring channel "slewing angle 2"	<ul style="list-style-type: none"> refer to E1A 	<ul style="list-style-type: none"> refer to E1A
E1C	Fallen below lower limit value in measuring channel "luffing jib angle"	<ul style="list-style-type: none"> Angle potentiometer defective 	<ul style="list-style-type: none"> Replace angle sensor
		<ul style="list-style-type: none"> Electronic component in the measuring channel defective. 	<ul style="list-style-type: none"> Replace sensor unit
E21	Upper limit value in measuring channel "main boom length" has been exceeded.	<ul style="list-style-type: none"> refer to E11 	<ul style="list-style-type: none"> refer to E11
E22	Upper limit value in measuring channel "pressure piston side" has been exceeded	<ul style="list-style-type: none"> refer to E12 	<ul style="list-style-type: none"> refer to E12
E23	Upper limit value in measuring channel "pressure rod side" has been exceeded.	<ul style="list-style-type: none"> refer to E12 	<ul style="list-style-type: none"> refer to E12
E24	Upper limit value in measuring channel "force" has been exceeded.	<ul style="list-style-type: none"> refer to E14 	<ul style="list-style-type: none"> refer to E14

Troubleshooting

Fault code	Error	Cause	Elimination
E25	Upper limit value in measuring channel "main boom angle" has been exceeded.	<ul style="list-style-type: none"> refer to E15 	<ul style="list-style-type: none"> refer to E15
E26	Upper limit value in measuring channel "angle 2" has been exceeded.	<ul style="list-style-type: none"> refer to E16 	<ul style="list-style-type: none"> refer to E16
E27	Upper limit value in measuring channel "length telescope I (+II) has been exceeded.	<ul style="list-style-type: none"> refer to E17 	<ul style="list-style-type: none"> refer to E17
E2A	Upper limit value in measuring channel "slewing angle 1" has been exceeded slew above allowed range	<ul style="list-style-type: none"> refer to E1A 1-cannel slew sensor max. value DGA 11.5.8 <> 0 	<ul style="list-style-type: none"> refer to E1A move to allowed slew range
E2B	Upper limit value in measuring channel "slewing angle 2" has been exceeded	<ul style="list-style-type: none"> refer to E1A 	<ul style="list-style-type: none"> refer to E1A
E2C	Upper limit value in measuring channel "luffing jib angle" has been exceeded	<ul style="list-style-type: none"> Angle potentiometer defective Electronic component in the measuring channel defective. 	<ul style="list-style-type: none"> Replace angle sensor Replace sensor unit
E31	Error in the system program	<ul style="list-style-type: none"> The system program file is defective. Flash-EEPROM defective 	<ul style="list-style-type: none"> Upload valid system software Replace central unit
E32	Error in the power supply	<ul style="list-style-type: none"> +UB System not present at the system start +UB System not present at the system finish Contact problems at +UB switch off/on 	<ul style="list-style-type: none"> +UB System and +UB Power must be wired separately: +UB System connected direct with the crane battery. +UB Power for switch on/off +UB switch off/on again
E37	Error in the logical program flow	<ul style="list-style-type: none"> System program file is defective Flash-EEPROM defective 	<ul style="list-style-type: none"> Upload valid system software Replace central unit
E38	System program and crane data file do not match.	<ul style="list-style-type: none"> The system program in the LMI does not match to the programming in the crane data file 	<ul style="list-style-type: none"> Upload valid system program file or the valid crane data file
E39	System program and load chart file do not match	<ul style="list-style-type: none"> The system program in the LMI and the programming in the load chart file do not match. 	<ul style="list-style-type: none"> Upload valid system program file or the valid load chart file
E43	Error in the write/read memory, (RAM)	<ul style="list-style-type: none"> Write/read memory (RAM) or central unit defective. 	<ul style="list-style-type: none"> Replace central unit

Troubleshooting

Fault code	Error	Cause	Elimination
E47	<p>Error in the monitored write/read memory.</p> <p>The CRC verification of the monitored write/read memory provides an incoherent result</p>	<ul style="list-style-type: none"> The CRC sign of the monitored write/read memory is wrong The buffer battery is discharged (< 2V at 1kOhm). Central unit defective. 	<ul style="list-style-type: none"> Restart the LMI Replace buffer battery on the central unit. Replace central unit
E51	Error in the crane data file	<ul style="list-style-type: none"> No valid data in the crane data file. Flash-EPROM defective 	<ul style="list-style-type: none"> Upload valid crane data file Replace central unit
E52	Error in load chart file.	<ul style="list-style-type: none"> No valid data in the load chart file Flash-EPROM defective 	<ul style="list-style-type: none"> Upload valid load chart file Replace central unit
E53	Wrong setup of min. analog inputs length1, angle1, pressure1	<ul style="list-style-type: none"> Analog input not supported 	<ul style="list-style-type: none"> Setup correct Flag in in DGA 6.i.2
E56	Error in crane data file.	<ul style="list-style-type: none"> No valid data in the crane data file during calibration. Flash-EPROM defective 	<ul style="list-style-type: none"> Restore or upload valid crane data file Replace central unit
E57	Error in buffered data file.	<ul style="list-style-type: none"> Buffered data file does not contain valid data. Flash-EPROM defective 	<ul style="list-style-type: none"> Reset system Replace central unit
E61	Error in the CAN bus data transfer for all CAN units	<ul style="list-style-type: none"> CAN Bus cable between the central unit and the sensor unit defective or not connected. 	<ul style="list-style-type: none"> Check the connection between the central unit and the sensor units
		<ul style="list-style-type: none"> Can bus port in the central unit defective 	<ul style="list-style-type: none"> Replace the central unit
		<ul style="list-style-type: none"> Short circuit in a CAN Bus cable 	<ul style="list-style-type: none"> Replace Can Bus cable
E62	Error in the can bus data transfer of the pressure transducer sensor unit	<ul style="list-style-type: none"> Cable between the central unit and the sensor unit defective. 	<ul style="list-style-type: none"> Check the cable to the sensor unit
		<ul style="list-style-type: none"> Can bus port in the central unit defective 	<ul style="list-style-type: none"> Replace the central unit
		<ul style="list-style-type: none"> Can bus port in the sensor unit is defective 	<ul style="list-style-type: none"> Replace the sensor unit
		<ul style="list-style-type: none"> Sensor unit is defective 	<ul style="list-style-type: none"> Replace the sensor unit
E63	Error in the can bus pressure transducer sensor unit	<ul style="list-style-type: none"> The analog values of the sensor unit are invalid 	<ul style="list-style-type: none"> Replace the sensor unit
E64	Error in the can bus data transfer of the length/angle sensor unit	<ul style="list-style-type: none"> See E62 	<ul style="list-style-type: none"> See E62
E65	Error in the can bus length/angle sensor unit	<ul style="list-style-type: none"> See E63 	<ul style="list-style-type: none"> See E63
E66	Error in the data of the digital I/O MENTOR	<ul style="list-style-type: none"> PDB variable invalid 	<ul style="list-style-type: none"> Change system software Change MENTOR
E67	Error in the can bus data transfer of the digital I/O external module	<ul style="list-style-type: none"> PDB variable invalid 	<ul style="list-style-type: none"> Connect digital I/O external CAN module

Troubleshooting

Fault code	Error	Cause	Elimination
E84	Wrong rigging condition.	<ul style="list-style-type: none"> The selected rigging condition is not contained in the crane data file. 	<ul style="list-style-type: none"> Select another rigging condition Check the programming in the crane data file.
E85	Error in the radius determination	<ul style="list-style-type: none"> The computed radius is too small (negative deflection) 	<ul style="list-style-type: none"> Check the programming in the crane data file.
E89	Operating mode switchover with load.	<ul style="list-style-type: none"> The operating mode on the console has been switched over with the boom loaded. 	<ul style="list-style-type: none"> Select operating mode without load on the boom
E98	LMI watchdog activated	<ul style="list-style-type: none"> LMI processing time limit exceeded 	<ul style="list-style-type: none"> Reset system Connect PC terminal and watch error messages
EAB	Short circuit in the A2B switch circuit (not with radio A2B)	<ul style="list-style-type: none"> Short circuit in the A2B switch Short circuit in the cable to the A2B switch 	<ul style="list-style-type: none"> Replace A2B switch Replace cable to the A2B switch
EAC	A2B switch circuit disconnected (not with radio A2B)	<ul style="list-style-type: none"> Disconnected cable in the A2B switch Disconnected cable to the A2B switch 	<ul style="list-style-type: none"> Connect or replace cable in the A2B switch Connect or replace cable to the A2B switch
EAD	No valid A2B switch status	<ul style="list-style-type: none"> Sensor wrong function CAN bus delay Radio telegram delay module (radio A2B) Radio telegram ID is invalid 	<ul style="list-style-type: none"> Replace A2B switch Replace cable to the A2B switch Replace battery of radio module (radio A2B) Setup ID in DGA12.9
EDB	Datalogger setup error	<ul style="list-style-type: none"> Setup of the datalogger is cleared (ser. crane data file or battery buffered RAM) 	<ul style="list-style-type: none"> transfer data and setup datalogger again
EDC	Datalogger watchdog activated	<ul style="list-style-type: none"> datalogger processing time limit exceeded 	<ul style="list-style-type: none"> Reset system Connect PC terminal and watch error messages
EDD	Battery empty	<ul style="list-style-type: none"> Battery check detected a low voltage of the battery 	<ul style="list-style-type: none"> change batterie, after this setup of RTC
EDE	Record lost	<ul style="list-style-type: none"> Not possible to save data because other task saves data at the same time 	<ul style="list-style-type: none"> Message disappears after a few seconds
EDF	Flash block full	<ul style="list-style-type: none"> Not possible to save any more data 	<ul style="list-style-type: none"> Message disappears after a few seconds
EFD	LMI Watchdog extra time	<ul style="list-style-type: none"> a funktion needs more than 0.5 sec, e.g. Flash PROM write 	<ul style="list-style-type: none"> Message disappears after a few seconds

Note:

If a fault message is displayed that is not included in the present list, then please contact your local Hirschmann Customer Service. > www.hirschmann-ac.de <

Appendix: Menu structure overview (info and service menus)

▼ Start screen

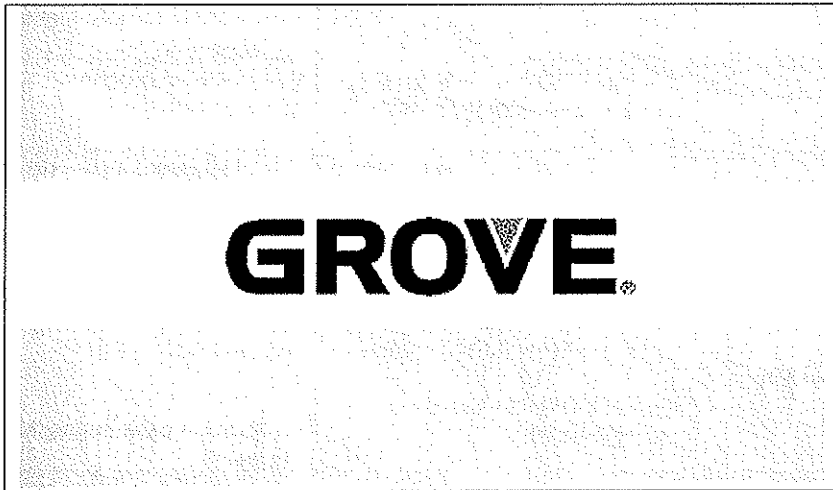
	<p>SYSTEM START SCREEN</p> <p>No function keys available.</p> <p>Screen automatically changes after completion of the system test.</p>
---	---

▼ LMI main screen (1st level of function keys)

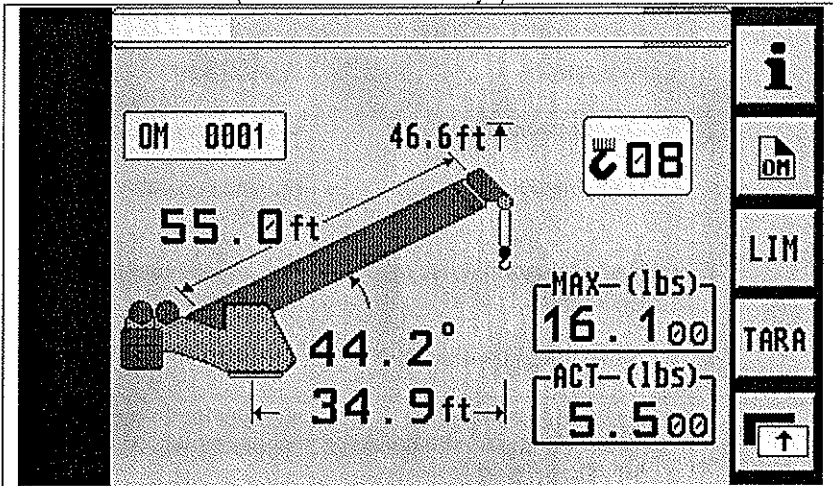
	<p>show info screen</p> <p>start operation mode selection</p> <p>show LIMITS menu</p> <p>start TARE function</p> <p>switch to 2nd level of function keys</p>
--	---

▼ LMI main screen (2nd level of function keys)

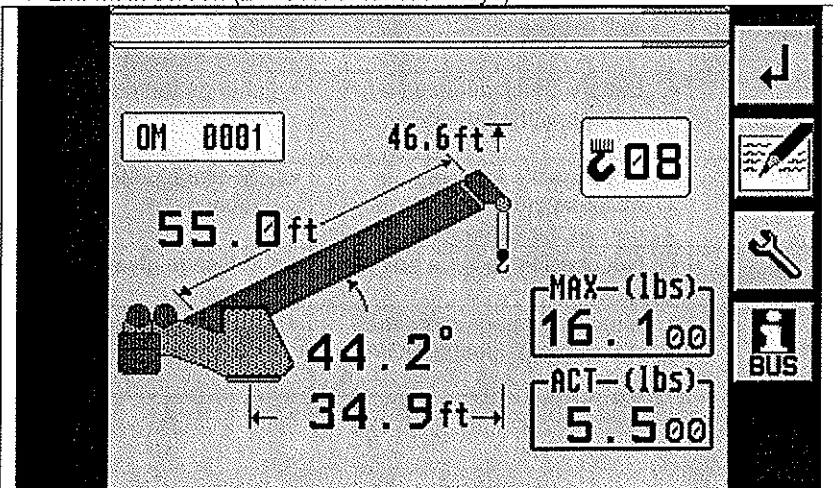
	<p>back to the previous menu</p> <p>show LMI value screen</p> <p>show service menu</p> <p>show CAN-bus menu</p>
---	---

Appendix: Menu structure overview (info and service menus)

▼ start INFO screen (overview configuration)

		back to the previous menu
		show sensor values
		show system info (node 1 / 2)
		input service code (for access to calibration menus)

▼ sensor values

		back to the previous menu
		input service code (for access to calibration menus)
		show system info (node 1 / 2)

▼ system info screens (node 1: expert compact)

<p>Node: 1 PAT-PDC D4 DISPLAY System Software - V 2.61- (c) 1998-2007 HAC GmbH Ettlin gen</p> <hr/> <p>I/O-configuration MOVGA - V1.00 HAC G mbH - (c) 16.11.2006</p> <hr/> <p>CAN mapping n1v003 Grove LMI with iF lex2-System</p> <hr/> <p>Grafik: Grove RT 530 expert compact -</p>		back to the previous menu
		scroll down next screen
		scroll up next screen

Appendix: Menu structure overview (info and service menus)

▼ system info screens (node 2: iFLEX2)

<pre> Node: 2 PAT-PDC iFLEX2 System Software - V 2. 60- (c) 2005-2007 HAC GmbH Ettlingen ----- I/O-configuration PAT dp - V1.00 PAT GmbH - (c) ----- CAN mapping n2v003 Grove LMI with iF lex2-System ----- iflex2 C LMB Software - LSQG V1.03/20 070411 - (c) HAC GmbH </pre>		back to the previous menu
		scroll down next screen
		scroll up next screen

▼ LMI value screen

<pre> LMI Values OM 000501 reev. 8 piston 1260.5 rod 143.7 angle 44.16 length 54.97 radius 34.91 act. Load 5.49 </pre>		back to the previous menu

▼ entry service menu

<p style="text-align: center;">SERVICE</p> <pre> Console LMI [OK] --- [OK] DAV LWG [OK] --- [OK] </pre>		back to the previous menu
	NODE 2	show I/O of iFLEX2
		input service code (for access to calibration menus)

Appendix: Menu structure overview (info and service menus)

▼ entry I/O of iFLEX2: digital inputs

<table border="1"> <thead> <tr> <th>DI</th><th></th><th>DI</th><th></th><th>DI</th><th></th></tr> </thead> <tbody> <tr> <td>0</td><td>49</td><td>6</td><td>55</td><td>12</td><td>61</td></tr> <tr> <td>1</td><td>50</td><td>7</td><td>56</td><td>13</td><td>62</td></tr> <tr> <td>2</td><td>51</td><td>8</td><td>57</td><td>14</td><td>63</td></tr> <tr> <td>3</td><td>52</td><td>9</td><td>58</td><td>15</td><td>64</td></tr> <tr> <td>4</td><td>53</td><td>10</td><td>59</td><td></td><td></td></tr> <tr> <td>5</td><td>54</td><td>11</td><td>60</td><td></td><td></td></tr> </tbody> </table>						DI		DI		DI		0	49	6	55	12	61	1	50	7	56	13	62	2	51	8	57	14	63	3	52	9	58	15	64	4	53	10	59			5	54	11	60				back to the previous menu
						DI		DI		DI																																							
						0	49	6	55	12	61																																						
						1	50	7	56	13	62																																						
						2	51	8	57	14	63																																						
						3	52	9	58	15	64																																						
						4	53	10	59																																								
5	54	11	60																																														
DIG OUT	show digital outputs																																																
ANA IN	show analog inputs																																																

▼ I/O of iFLEX2: digital outputs

<p style="text-align: center;">NODE2</p> <table border="1"> <thead> <tr> <th>DO</th><th></th><th>DO</th><th></th></tr> </thead> <tbody> <tr> <td>0</td><td>02</td><td>6</td><td>08</td></tr> <tr> <td>1</td><td>03</td><td>7</td><td>09</td></tr> <tr> <td>2</td><td>04</td><td>8</td><td>14</td></tr> <tr> <td>3</td><td>05</td><td>9</td><td>15</td></tr> <tr> <td>4</td><td>06</td><td>10</td><td>16</td></tr> <tr> <td>5</td><td>07</td><td>11</td><td>17</td></tr> </tbody> </table>						DO		DO		0	02	6	08	1	03	7	09	2	04	8	14	3	05	9	15	4	06	10	16	5	07	11	17		back to the previous menu
						DO		DO																											
						0	02	6	08																										
						1	03	7	09																										
						2	04	8	14																										
						3	05	9	15																										
						4	06	10	16																										
5	07	11	17																																
DIG IN	show digital inputs																																		
ANA IN	show analog inputs																																		

▼ I/O of iFLEX2: analog inputs

<p style="text-align: center;">NODE2</p> <table border="1"> <thead> <tr> <th>AI</th><th></th><th>AI</th><th></th></tr> </thead> <tbody> <tr> <td>0</td><td>34</td><td>70.1</td><td>4 38 50.4</td></tr> <tr> <td>1</td><td>35</td><td>81.4</td><td>5 39 0.1</td></tr> <tr> <td>2</td><td>36</td><td>86.4</td><td>6 40 100.3</td></tr> <tr> <td>3</td><td>37</td><td>16.8</td><td>7 41 0.1</td></tr> </tbody> </table>						AI		AI		0	34	70.1	4 38 50.4	1	35	81.4	5 39 0.1	2	36	86.4	6 40 100.3	3	37	16.8	7 41 0.1		back to the previous menu
						AI		AI																			
						0	34	70.1	4 38 50.4																		
						1	35	81.4	5 39 0.1																		
						2	36	86.4	6 40 100.3																		
						3	37	16.8	7 41 0.1																		
						DIG IN	show digital inputs																				
DIG OUT	show digital outputs																										

Appendix: Menu structure overview (info and service menus)

▼ input service code (for access to calibration menus)

 <p>The screen displays a key icon at the top. Below it, the text reads "Please enter servicecode:". Underneath, the number "55555" is shown, with the first digit "5" highlighted in a small box.</p>	<p>For access to the calibration menus it is necessary to input a matching 5-digit code.</p> <p>Use the rotary selection wheel to input a numeral, and then push the wheel button to select the next digit.</p> <p>If input is complete the confirmation screen appears:</p>
---	--

▼ input service code (confirmation screen)

 <p>The screen displays a key icon at the top. Below it, the text reads "Please enter servicecode:". Underneath, the number "55555" is shown. On the right side of the screen, there are two buttons: "OK" and "ESC".</p>	<table border="1"> <tr> <td data-bbox="889 844 982 940">OK</td> <td data-bbox="982 844 1510 940">OK, confirm selected code</td> </tr> <tr> <td data-bbox="889 940 982 1037">ESC</td> <td data-bbox="982 940 1510 1037">Cancel and return to LMI screen</td> </tr> <tr> <td data-bbox="889 1037 982 1134"></td> <td data-bbox="982 1037 1510 1134"></td> </tr> <tr> <td data-bbox="889 1134 982 1230"></td> <td data-bbox="982 1134 1510 1230"></td> </tr> <tr> <td data-bbox="889 1230 982 1329"></td> <td data-bbox="982 1230 1510 1329"></td> </tr> </table>	OK	OK, confirm selected code	ESC	Cancel and return to LMI screen						
OK	OK, confirm selected code										
ESC	Cancel and return to LMI screen										

>>

Appendix: Menu structure overview (info and service menus)

▼ Calibration screen (pressure transducer piston side)

		skip calibration step
		auto-calibrate (set to zero)
		cancel and return to LMI screen

▼ Calibration screen (pressure transducer rod side)

		skip calibration step
		auto-calibrate (set to zero)
		cancel and return to LMI screen

▼ Calibration screen (slewing angle)

		skip calibration step
		auto-calibrate (set to zero)
		cancel and return to LMI screen

Appendix: Menu structure overview (info and service menus)

▼ Calibration screen (boom length)

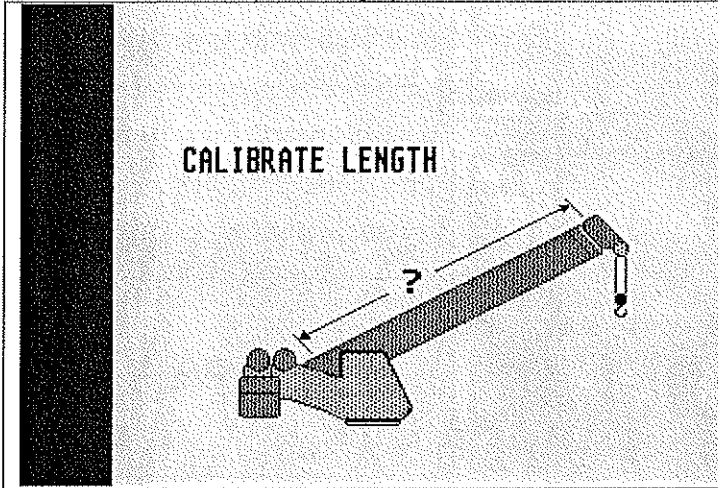
 <p>CALIBRATE LENGTH</p>	↩	skip calibration step
	OK	start length calibration
	ESC	cancel and return to LMI screen

▼ Start calibration minimum length

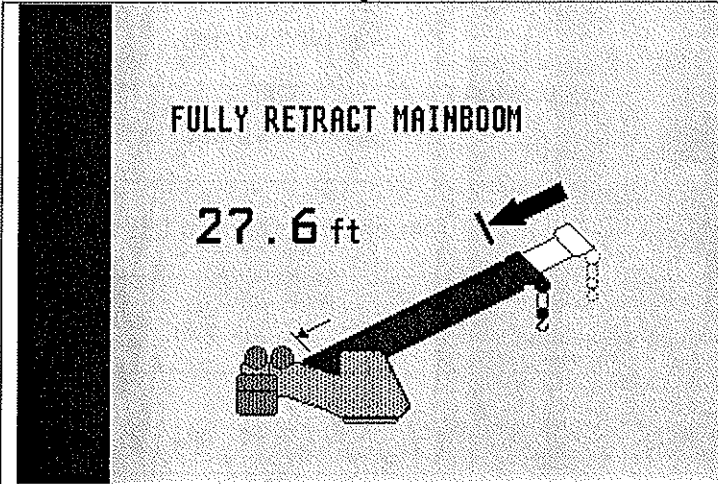

 <p>FULLY RETRACT MAINBOOM</p> <p>27.6 ft</p>	↩	skip calibration step
	ESC	cancel and return to LMI screen

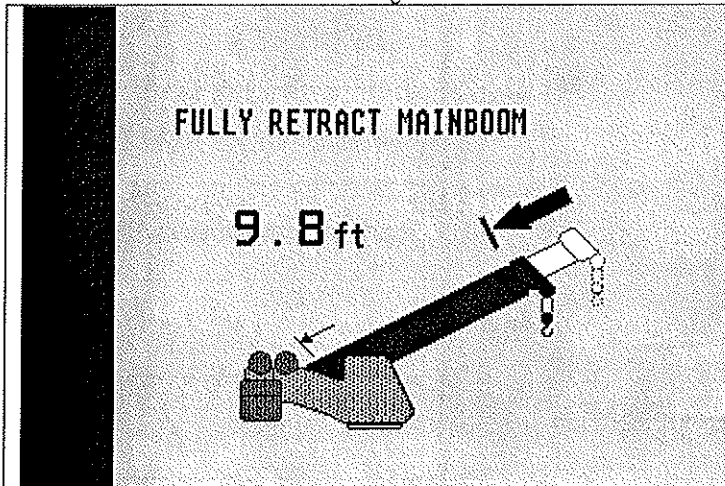
▼ Calibration screen minimum length

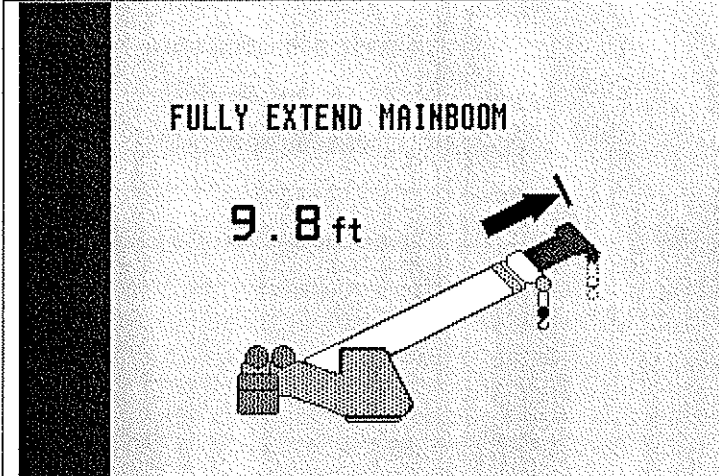

 <p>FULLY RETRACT MAINBOOM</p> <p>9.8 ft</p>	↩	skip calibration step
	OK	set minimum length
	ESC	cancel and return to LMI screen

Appendix: Menu structure overview (info and service menus)

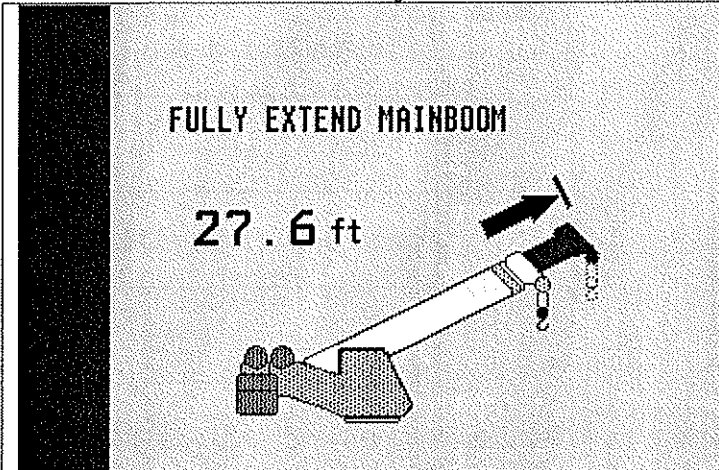

▼ Start calibration maximum length

		skip calibration step
	ESC	cancel and return to LMI screen

▼ Calibration screen maximum length

		skip calibration step
	OK	set maximum length
	ESC	cancel and return to LMI screen

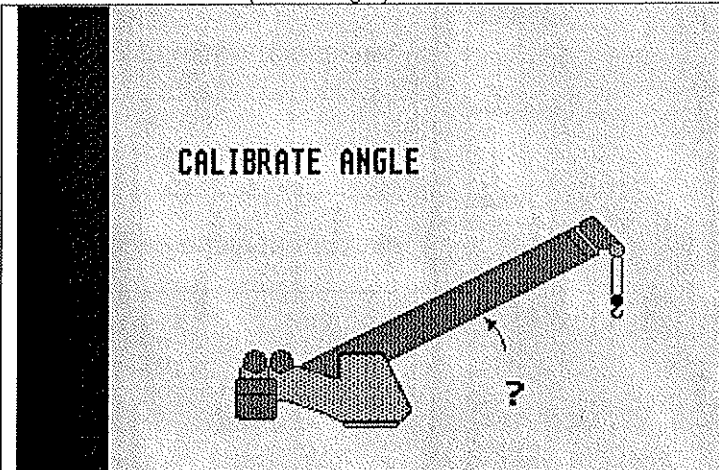
▼ Calibration screen (boom angle)

		skip calibration step
	OK	start angle calibration
	ESC	cancel and return to LMI screen

Appendix: Menu structure overview (info and service menus)

▼ Start calibration for "zero degree" angle

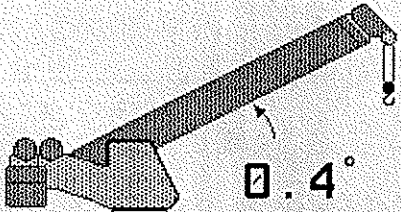
E02	<p>BOOM ANGLE MECH. 0-CAL.</p>  <p>0.4°</p>	<p>↩</p>	skip calibration step
		<p>OK</p>	Calibrate next angle
		<p>ESC</p>	cancel and return to LMI screen

▼ boom up to next angle

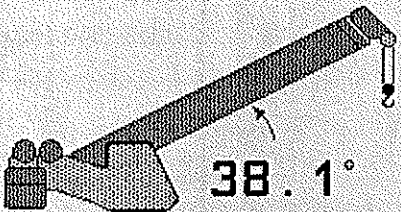
E01	<p>BOOM TO</p> <p>75.0°</p>  <p>38.1°</p>	<p>↩</p>	skip calibration step	
		<p>ESC</p>	cancel and return to LMI screen	

▼ calibrate angle

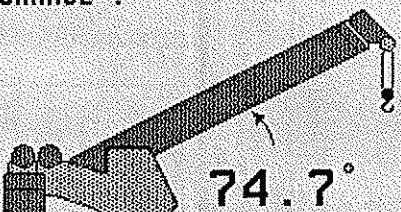
E01	<p>BOOM TO</p> <p>75.0°</p> <p>CHANGE ?</p>  <p>74.7°</p>	<p>ESC</p>	cancel and return to LMI screen
		<p>SET</p>	calibrate angle
		<p>OK</p>	set current angle to defined angle

Appendix: Menu structure overview (info and service menus)

▼ adjust angle

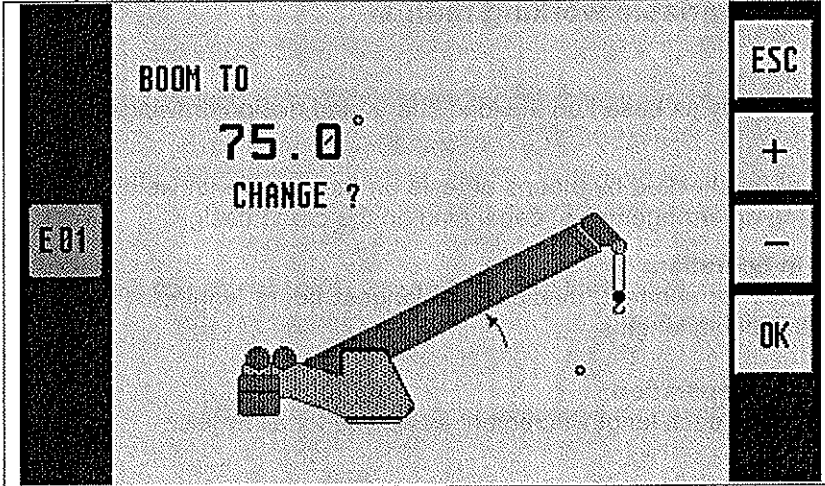
	ESC	cancel and return to LMI screen
	+	Increase angle value by 0.1°
	-	Decrease angle value by 0.1°
	OK	Confirm angle

Appendix: Important notes for crane operators and crane operating companies

INSTRUCTIONS 1 Shut-off values for boom cranes with variable load ratings depending on variable working radius

The crane shut-off values are determined by us based on the load charts and design drawings specified by the crane manufacturer.

These theoretical shut-off values must be checked by means of tests on the crane with weighed test loads for all modes and at least with the following rig arrangements, depending on the crane design.

- **Cranes with fixed boom length in operation:**
Smallest, medium and largest radius for shortest, medium and longest boom length, as well as shortest, medium and longest fly jibs for these boom lengths.
- **Cranes with boom length variable in operation:**
Smallest, medium and largest radius for each length increment as well as for all fly jibs.

INSTRUCTIONS 2 Important notes for the crane operator

The LMI is an operating aid to warn the crane operator of an imminent overload or of the hook block approaching the boom head, in order to avoid possible damage to property or personal injury.

This system cannot be, and is not intended to be, a substitute for good judgement or experience on the part of the crane operator, or for the application of recognised, safe working methods when using cranes. The crane operator is not released from his obligation to operate the crane safely. He must ensure that he fully understands and follows the notes and instructions displayed. Before beginning work with the crane, the crane operator must carefully read and understand the entire Manual to ensure that he is aware of the operation of the LMI and the crane. Proper functioning depends on due daily inspection of the system and compliance with the operating instructions listed in this Manual.

The system can only offer the crane operator help if the LMI is correctly adjusted, and the correct load chart and the correct operating code have been entered for the particular rig arrangement. To avoid damage to property and serious or even fatal injuries to persons, it is essential to ensure that the LMI is correctly adjusted before beginning crane work.



This system can be equipped with a key-operated switch which is located in the microprocessor central unit. This key-operated switch overrides the LMI's shut-off feature. The switch may only be actuated in emergencies by authorized personnel. Non-compliance with these instructions may lead to damage to property and serious or even fatal injuries to persons.

Appendix: Important notes for crane operators and crane operating companies

INSTRUCTIONS 3 Important notes for the crane operating company

In the Federal Republic of Germany, the design of overload safety devices for cranes is subject to the directives of VDI standard 3570 (VDI = Verein Deutscher Ingenieure - Association of German Engineers). The significance and the limitations of overload safety devices are also pointed out in this directive.

"In the operation of cranes, overload safety devices are intended to prevent accidents and risks to persons, property, the load and the crane as far as possible as a result of overloading. The crane operating company and the crane operator must remember that an overload safety device cannot detect all hazards in good time, and that a malfunction is possible through influences that are not apparent. For this reason, you cannot be released from your obligation to exercise due care and from your responsibility for complying with the operating regulations and the load limits of the crane. Overload safety devices must not be used for standard operation. They should only react in emergencies. The load rating of the hoisting equipment must not be reduced by an overload safety device."

VDMA Instruction Sheet for Overload Safety Devices (Automatic Safe Load Indicators) for Boom Cranes

According to § 24 of the UVV (provisions for the prevention of accidents) "Boom cranes", the boom crane delivered to you is equipped with an overload safety device (automatic safe load indicator) which switches off the crane's hoisting gear and the boom retracting mechanism when the admissible load moment is exceeded. In order to enable discharging after the overload safety device has reacted, it must still be possible to perform a contrary movement. This means, for example, that it must still be possible to lower the load after the hoisting gear has been switched OFF.

An overload safety device (automatic safe load indicator) is installed to prevent crane use for lifting of loads which endanger its stability. Thus, the overload safety device (automatic safe load indicator) is an emergency switch which, in case of crane overloads, shuts off all movements which might increase the load moment, and thus prevents possible damage or accidents. In order to enable the overload safety device to fulfil its functions as a safety unit, please pay attention to the following instructions:

1. Overload safety devices (automatic safe load indicators) must not be used for switching off the hoisting gear or the boom retracting mechanism during normal operation. The crane operator has to make sure in all cases before such work that the lifting capacity is not exceeded by the load to be lifted. Loads which exceed the lifting capacity of the crane must not be lifted in spite of the fact that the overload safety device is installed. This device must not be used for weighing purposes, and the crane must not be charged with loads exceeding the individually highest admissible load.
2. Tearing off fixed loads is only admissible if the crane manufacturer has agreed to it, and only with cranes which are specially equipped for this purpose. During such operations, the overload safety device (automatic safe load indicator) must not be used as load measuring equipment for normal operation.
3. The overload safety device installed in the crane must be serviced at regular intervals and checked for safe operation before crane work. According to § 35 of the UVV (Provisions for the Prevention of Accidents) "Boom cranes", crane maintenance work also comprises regular inspections of the overload safety device.
4. In general, the overload safety device is not automatically adjusted to the different modes of operation of the crane. Therefore the crane operator is obliged to adjust the overload safety device to a different range of lifting capacities or load moments, when the mode of operation of the crane is altered. To this effect, the operating instructions of the manufacturer of the installed overload safety device must be complied with. Safe operation of the machine and crane work free of accidents depend to a large extent on careful compliance with these instructions. An incorrectly set overload safety device, e.g. a device which is set to a high load moment while the outriggers are retracted, is considerably more dangerous than a crane without an overload safety device, as it conveys a feeling of safety to the driver, which is in fact not justified, and which may cause serious accidents.

Appendix: Important notes for crane operators and crane operating companies

5. The overload safety device (automatic safe load indicator) installed must be adjusted by the crane driver to the different ranges of lifting capacities or load moments, when the crane is adjusted to different modes of operation, such as:
 - a) when the outriggers are extended or retracted (switching over to the high or low load moment)
 - b) when the boom length is changed by:
 - manual extending and retracting (telescoping)
 - mounting or dismounting intermediate elements;
 - c) when the crane is swung or slewed into the range of the higher or lower stability moment (switching over to the high or low load moment)
 - d) when changing over to a different lifting capacity range by fitting multiple rope falls to the hoisting gear or the boom retracting mechanism.

6. Please note positively that the overload safety device cannot become effective, i.e. the drive assembly cannot be switched off quickly enough when the crane is operated incorrectly. In this case, accidents cannot be precluded completely in spite of the overload safety device being installed. This applies particularly to the following cases:
 - the hook or the load lifting equipment is fixed underneath the load;
 - excessive time-lag forces are effective;
 - loads are dropped into the rope;
 - the load is pulled diagonally;
 - moving the crane in an area with significant ground slope;
 - subsiding subsoil;
 - wind load.

7. If an equipment for switching off or overriding the overload safety device (automatic safe load indicator) is installed, it may only be used if particular precautions have been taken, and in the presence of the crane supervisors, e.g. during crane inspections and during the operations intended by the crane manufacturer.

Careful compliance with the provisions comprised in this instruction sheet and in the operating manual of the crane manufacturer is a prerequisite to safe operation of the overload safety device (overload disconnect unit).

Should you have any doubts, please consult the manufacturer's Operating Manual. If it does not provide sufficient information, it will be necessary to contact the company in question.

Unauthorized tampering with the overload safety device's mechanical components will rule out all warranty claims.

Issued by: VDMA Fachgemeinschaft für Hebezeuge und Fördermittel
im Verein Deutscher Maschinenbau-Anstalten e.V.
Düsseldorf-Oberkassel

Appendix: Important notes for crane operators and crane operating companies

INSTRUCTIONS 4 Notes on Electromagnetic Compatibility (EMC) in electronic systems taking account of the effect of electromagnetic fields

Electromagnetic fields are having an increasing effect on electronic systems and may lead to malfunctions; to avoid these, we have listed preventive measures in the following, according to the latest state of technology:

1. The preventive measures proceed primarily from the basic idea that the electronic circuits should be shielded from irradiated high frequencies by a closed, low-resistance protective skin against high-frequency interference.
 - All components are equipped with metallic outer housings with earthing option;
 - only cables with a braided screen are used. The screen must generously cover all connectors and must be of high conductivity;
 - coupling of the crane earth and the electronics earth in one single point of the system only.
2. The general precautions listed under Section 1 cannot assure complete protection against electromagnetic fields in all cases, however, since the size and type of effect depend on local conditions.

Examples of such influencing factors are:

- particularly unfavourable arrangement of the aerials in relation to the system,
- very high transmission power,
- consistent compliance with measures of Section 1 not possible due to local conditions,
- long cables,
- coupling of interference into the supply leads.

In unfavourable conditions, one has no choice but to take experimental measures on site, in addition to the preventive measures, while taking account of the principles mentioned in Section 1, for example:

- fitting filters or short-circuiting the interference frequencies using capacitors;
- establishing or separating earth connections;
- using a guarded shield system.

Appendix: Important notes for crane operators and crane operating companies

INSTRUCTIONS 5 Notes on industrial safety when repairing display and control consoles

Caution: Liquid crystal displays contain liquid chemical substances in the display. Particular caution and care are therefore necessary:

- when operating equipment containing liquid crystal displays
- during storage and transport (risk of breakage !)
- when disposing of unusable or excess liquid crystal displays

Possible sources of danger are chemical effects in the event of skin contact with broken liquid crystal displays. In the event of contact, wash the affected skin areas thoroughly with soap. Be particularly careful with open wounds !

INSTRUCTIONS 6 Installation instructions for display and control consoles without closed metallic housing

To avoid radio interference, high-frequency devices and equipment coming under general approval requirements published by the Federal Minister for Post and Telecommunications in his Official Gazette No. 163/1984 as Decree No. 1045/1984 and No. 1046/1984 must comply with the limit values and conditions laid down there.

For display and control consoles without closed metallic housing (dashboard installation version), the conductor screen must therefore be mounted on the dashboard directly in front of the console by means of a bare cable clip.

Revision History

Version	Date	Modifications	Name
Rev. A	2007-05-25	First Issue for Grove RT 530 LMI with iFLEX2 System Grove RT 530 expert compact V 1.04 / 20070511 – © HAC GmbH - 34230104	Konopka

